

1928-31 Bumpers

1928-31 Bumper Face Bars

Full width bars were used on front, can be used on rear. Clamps and end hardware shown are not included with bumper face bars.

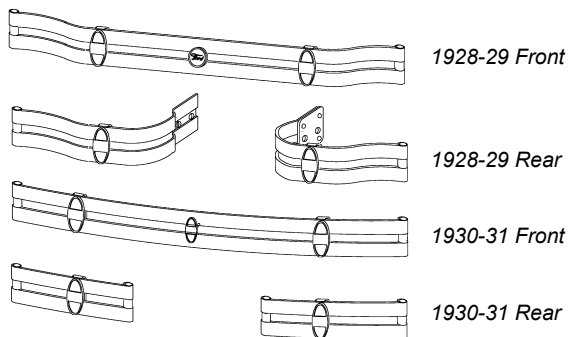

Full Width Face Bars

A-17757-CSS	1928-29, With end eyes, stainless	575.00 set
A-17757-DSS	1930-31, 61" wide, stainless	575.00 set

Rear Bumperette Bar Sets

A-17784-CSS	1928-29, Stainless	625.00 set
A-17784-DSS	1930-31, Stainless	575.00 set

1926-31 Bumper Clamps and End Bolts:

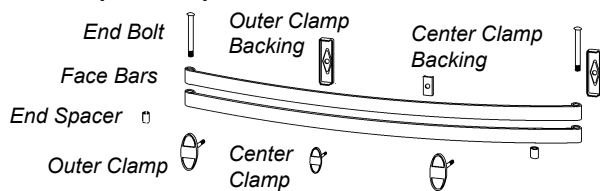

Outer Bumper Clamps

T-17758	1926-27 Outer clamp, black	12.50 ea
T-17758-C	1926-27 Outer clamp, chrome	15.00 ea
A-17758-CF	1928-30 Clamp, steel, chrome	45.00 ea
A-17758-DF	1930-31 Clamp, steel w/stls cover	20.00 ea

Outer Bumper Clamp Backing Plates

A-17756-B	1929-31, Stamped, plain	7.50 ea
-----------	-------------------------	---------

Center Bumper Clamps

Steel with stainless cover:

A-17762-A	1927 Round, "Ford made in USA"	17.50 ea
A-17762-B	1927-28 Round, "Ford"	17.50 ea
A-17762-C	1928-31 Oval, no script	15.00 ea

Center Bumper Clamp Backing Plate

A-17765-A	1927-28 (using round clamp)	1.50 ea
A-17762-B	1929-31 (using oval clamp)	17.50 ea

Bumper End Bolts & Spacers

A-17834	End bolt, plain	12.50 ea
A-17834-C	End bolt, stainless	17.50 pr
A-17759	End spacer, plain	2.50 pr
A-17759-C	End spacer, stainless	5.00 ea

Front Bumper Brackets



A-17754-AS	1928-29, stock style, plain	125.00 pr
A-17754-BS	1930-31, stock style, plain	125.00 pr
A-17754-SS	1930-31, stock style, stainless	not.avbl
	can be used on 1928-29, moves bumper back	
A-17754-SS32	1928-31, uses 1932 bumper, stainless	not.avbl

1928-29 Bumper Brackets to Frame Bolts

A-17754-SKSS	Stainless	15.00 set
--------------	-----------	-----------

1930-31 Front Bumper Bracket & Splash Apron Studs

Set of 4 special studs that mount the front bumper brackets and space the front splash apron from the frame.

A-16527-AS	studs	30.00 set
------------	-------	-----------

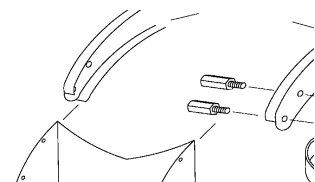

Rear Bumper Bracket Parts:

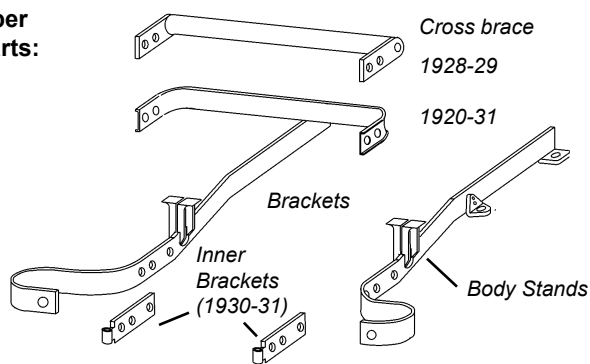

Rear Bumper Brackets: (with body stands)

A-17777-CR	1928-31 Coupe & Roadster	425.00 pr
A-17777-AS	1928-29 Sedans, 1928-31 4-Door Phaeton	425.00 pr
A-17777-BS	1930-31 Tudor sedan	425.00 pr

Rear Inner Brackets: (used on 1930-31 only)

A-17777-I	1930-31 Coupe, Roadster, Sedan, Phaeton	27.50 ea
-----------	---	----------

Bumper Cross Members:

A-17783-A	1928-30 Rear cross tube, plain	90.00 ea
A-17783-AS	1928-31 Rear cross tube, stainless	not.avbl
A-17783-B	1930-31 Rear cross 1/2 round bar	75.00 ea

Rear Bumper Bracket to Body Stands only

A-17778-B5	1928-31 Coupe & Roadster, 5" tall	not.avbl
A-17778-B4	1930-31 Sedan, 4.5" tall	not.avbl
A-17778-B3	1928-29 Sedan, 3" tall	not.avbl

Model A Luggage Rack

Stamped steel, chrome plated with wood trim and mounting brackets.

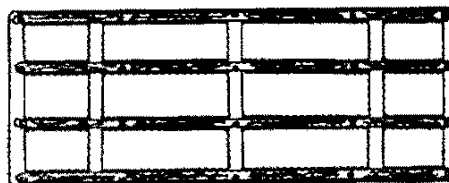

A-18575		130.00 ea
---------	--	-----------

* Parts with price listed as "not.avbl" are not known to be available at this time, but are listed for reference.

1932-36 Bumpers

1932 Bumper and Bolts

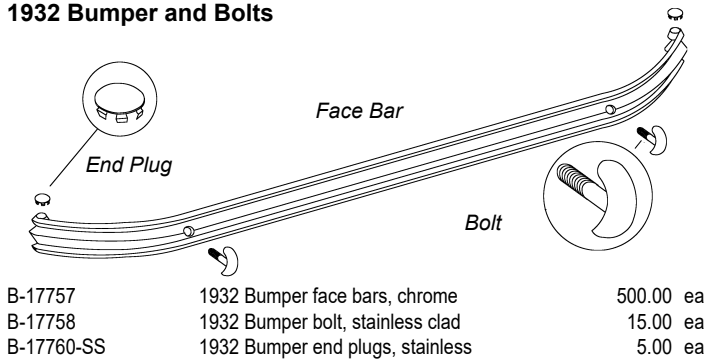

B-17757	1932 Bumper face bars, chrome	500.00 ea
B-17758	1932 Bumper bolt, stainless clad	15.00 ea
B-17760-SS	1932 Bumper end plugs, stainless	5.00 ea

1933-36 Bumper Face Bars

Passenger and Pickup bumpers of the same year are interchangeable

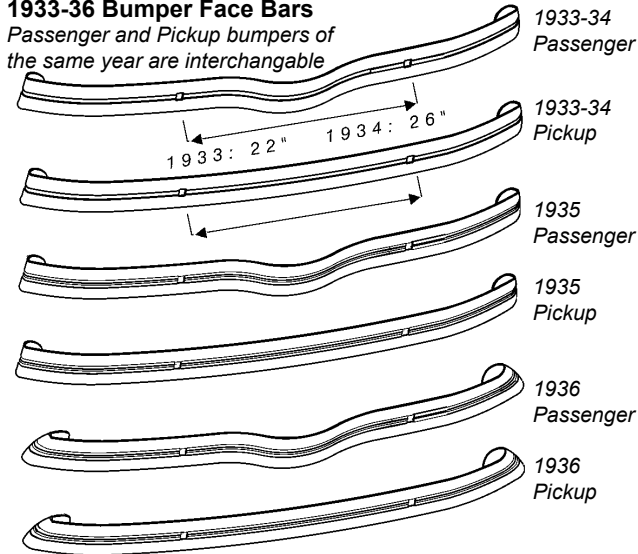

	Chrome		Stainless	
1933 Passenger	40-17757-A	425.00 ea	40-17757-AS	not.avbl
1933 Pickup	46-17757-A	not.avbl	46-17757-AS	not.avbl
1934 Passenger	40-17757-B	425.00 ea	40-17757-BS	not.avbl
1934 Victoria Rear	40-17757-V	not.avbl		
1934 Pickup	46-17757-B	not.avbl	46-17757-BS	not.avbl
1935 Passenger	48-17757	not.avbl	48-17757-S	not.avbl
1935 Pickup	50-17757	not.avbl	50-17757-S	not.avbl
1936 Passenger	68-17757	not.avbl	68-17757-S	not.avbl
1936 Pickup	67-17757	not.avbl	67-17757-S	not.avbl

Bumper Bolts

40-17758	Oval, bumper face, stainless	7.50 ea
B-42034-P	Round, bumper end, plain	0.50 ea
B-42034-S	Round, bumper stainless clad	0.75 ea

1932-36 Front Bumper Brackets

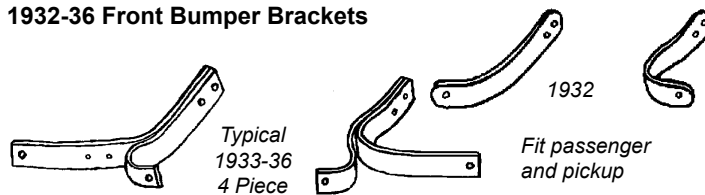

	Mild Steel		Stainless	
1932 Stock	B-17754-S	not.avbl	B-17754-SS	not.avbl
1932 Shortie	B-17754-SH	not.avbl	B-17754-SSH	not.avbl
1933	40-17754-AS	not.avbl	40-17754-ASS	not.avbl
1934	40-17754-BS	not.avbl	40-17754-BSS	not.avbl
1935	48-17754-S	not.avbl	48-17754-SS	not.avbl
1936	68-17754-S	not.avbl	68-17754-SS	not.avbl

1932 Front Bumper Bracket Mount Kit

Includes special studs to offset splash apron from frame. Bolts and studs mount bumper brackets and front spreader bar to frame
B-16525-S 1932 Passenger and Pickup 30.00 set

1932-36 Rear Bumper Bracket Sets

Ford did not supply rear bumpers for 1932-35 Pickups

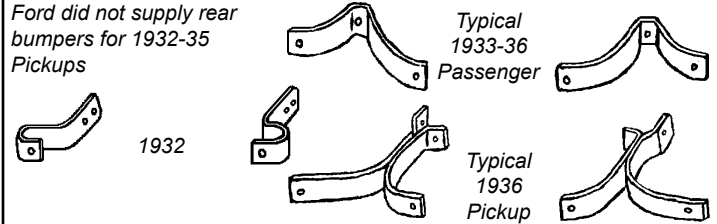

	Mild Steel		Stainless	
1932 Passenger Stock	B-17314-AS	not.avbl	B-17314-SS	not.avbl
1932 Pass Shortie	B-17314-ASH	not.avbl	B-17314-SSH	not.avbl
1933 Pass, Stock	40-17314-AS	not.avbl		
1933 Pass, Shorty	40-17314-AH	not.avbl	40-17314-AHS	not.avbl
1934 Pass, Stock	40-17314-BS	not.avbl		
1934 Pass, Shorty	40-17314-BH	not.avbl	40-17314-BHS	not.avbl
1934 Victoria	40-17314-VS	not.avbl		
1935 Pass Stock	48-17314-S	not.avbl		
1936 Pass Stock	68-17314-S	not.avbl		
1935-36 Pass Shorty	48-17314-H	not.avbl	48-17314-HS	not.avbl
1935-36 Pickup	67-17314-S	not.avbl		

Front License Plate Bracket

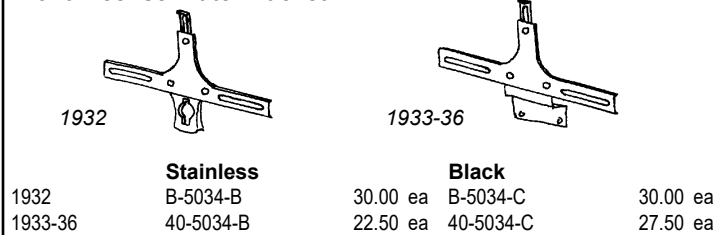

	Stainless		Black	
1932	B-5034-B	30.00 ea	B-5034-C	30.00 ea
1933-36	40-5034-B	22.50 ea	40-5034-C	27.50 ea

Bumper Guards

1933-34 All models:

40-17996 50.00 ea

1933-34 bumper guard bolts

40-17758-R 7.50 ea

1935 All models:

48-17996 65.00 ea

1936 All models:

68-17996 not.avbl

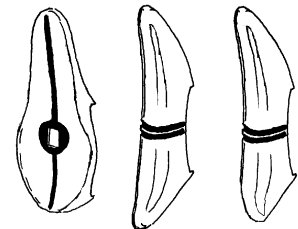

1935-36 Front Bumper Arm Grommets

1935 Passenger & Commercial:

(hole in fender for bumper arm)

48-17772-S 27.50 pr

1936-37 Commercial:

(notch in fender for bumper arm)

50-17772/3 27.50 pr

1936-37 Passenger:

68-17772/3 27.50 pr

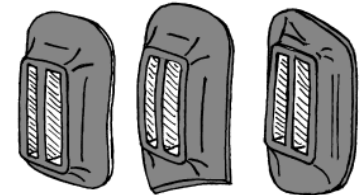

1934 Victoria Rear Bumper Arm Grommets

40-17792-V 1934 Victoria, rubber not.avbl

* Parts with price listed as "not.avbl" are not known to be available at this time, but are listed for reference.

1937-40 Passenger, 1937-41 Pickup Bumpers

Bumper Face Bars

1937-38 & 1939 Std & Pickup

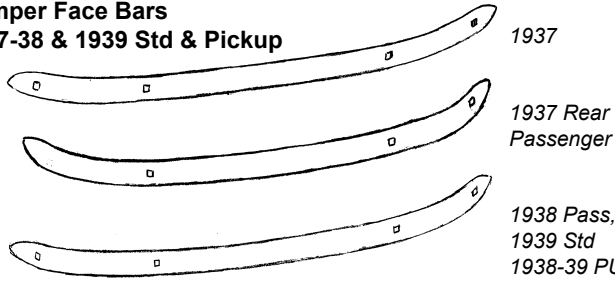

Chrome		Stainless		
1937 Front (& PU rear)	78-17757-A	not.avbl	78-17757-AS	not.avbl
1937 Pass Rear	78-17757-B	not.avbl	78-17757-BS	not.avbl
1938 Pass, 1939 Std	81A-17757	not.avbl	81A-17757-S	not.avbl
1938-39 Pickup				

Bumper Face Bars

1939 Deluxe, 1940 Passenger, 1940-41 Pickup

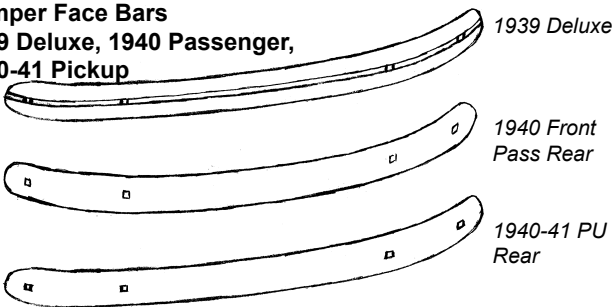

Chrome bumper face bars have stock mounting holes. Smooth stainless face bars have studs welded and do not have exposed bolt heads.

Chrome		Smooth Stainless		
1939 Deluxe	91A-17757	not.avbl	91A-17757-HR	not.avbl
1940 Passenger	01A-17757	not.avbl	01A-17757-HR	not.avbl
1940-41 Pickup Front	01A-17757	not.avbl	01A-17757-HR	not.avbl
1940-41 PU Rear	01C-17757	not.avbl	01C-17757-HR	not.avbl

Bumper Guards, Chrome Plated

1937 All models		
78-17996	not.avbl	
1939 Deluxe passenger		
91A-17996	65.00 ea	
1940 All models		
01A-17996	not.avbl	

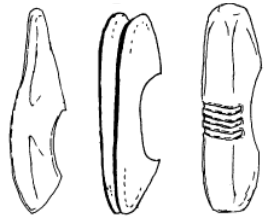

1940 Grille Guard

Ford script, steel, chrome plated

01A-17799	375.00 ea
-----------	-----------

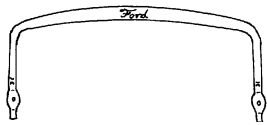

Bumper Face Bolts

Oval Head

Stainless, fine thread

1933-40 Oval Head

40-17758	1 1/4" long	7.50 ea
----------	-------------	---------

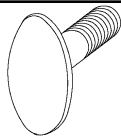

Front License Plate Brackets

1937-38 Pass & 1939 Std, 1937-39 Pickup:

78-5034-B	Black	not.avbl
78-5034-C	Stainless	not.avbl

1939 Deluxe, All 1940, 1940-41 Pickup:

91A-5034-B	Black	22.50 ea
91A-5034-C	Stainless	27.50 ea

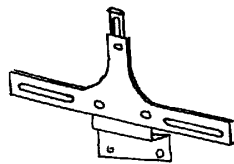

Front Bumper

Brackets (Set of 4)

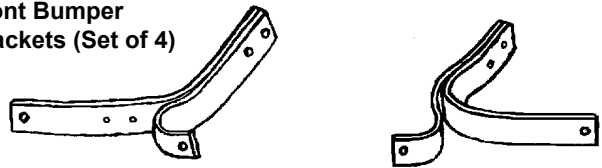

Plain		Stainless		
1937	78-17754-S	not.avbl	78-17754-SS	not.avbl
1938 Pass, 1939 Std	81A-17754-S	not.avbl	81A-17754-SS	not.avbl
1938-39 Pickup				
1939 Deluxe	91A-17754-S	not.avbl		
1940 Pass, 40-41 PU	01A-17754-S	not.avbl	01A-17754-SS	400.00 ea

Front Bumper Arm Grommets, rubber

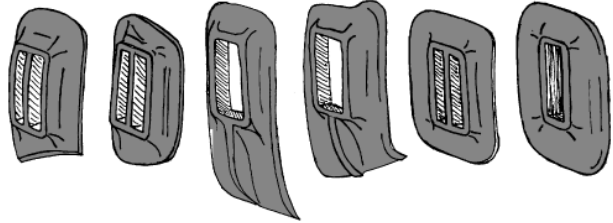

68-17772/3	1936-37 Passenger, 1938 Standard	27.50 pr
81A-17772/3	1938 Deluxe, 1939 Standard	27.50 pr
81C-17772/3	1938-39 Commercial	27.50 pr
99A-17772-S	1939-40 Mercury	42.50 pr
01A-17772/3	1939-40 Deluxe, 1940 Std, 1940-41 1/2 Ton	27.50 pr

Rear Bumper

Brackets (set of 4)



Plain		Stainless		
1937 Passenger	78-17314-S	not.avbl	78-17314-SS	not.avbl
1937 Pickup	77-17314-S	not.avbl		
1938 Pass, 1939 Std	81A-17314-S	not.avbl	81A-17314-SS	not.avbl
1938-41 Pickup	81C-17314-S	not.avbl		
1939 Deluxe	91A-17314-S	not.avbl		
1940 Passenger	01A-17314-S	not.avbl	01A-17314-SS	400.00 ea

Rear Bumper Arm Grommets, rubber

1937-40 Coupe Convertible,

1937 Sedans and Phaeton,

1938 Standard Sedans:

78-17792/3	27.50 pr
------------	----------

1938 Deluxe Sedan

1939-40 Sedan:

81A-17792/3	27.50 pr
-------------	----------

1940-41 Sedan Delivery:

01A-17792	37.50 pr
-----------	----------

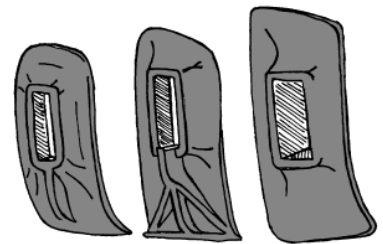

Rear Bumper Splash & Rock Guards

Mounts to bumper bracket and helps deflect rocks and splash from coming up onto rear deck.



BSA40P	1940 Passenger: fiberglass	230.00 ea
--------	----------------------------	-----------

* Parts with price listed as "not.avbl" are not known to be available at this time, but are listed for reference.

1941-48 Passenger Bumpers

1941 Passenger Bumper Arm Grommets

11A-17772/3	Front	27.50 pr
11A-17792/3	Rear	27.50 pr

1942-48 Front Bumper Bracket to Bumper

Apron Bumpers, rubber

21A-17749-B	Set of 4	20.00 set
-------------	----------	-----------

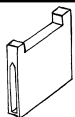

1946-48 Rear Bumper Splash Guards

Mounts to bumper bracket and helps deflect rocks and splash from coming up onto rear deck.

6A-17808	Splash guard, Stamped Steel	275.00 ea
6A-17832	Splash guard to body rubber seal	20.00 ea

Bumper Face Bolts

Stainless clad, fine thread

1941-48 Square Head

11A-17758	1 1/4" long	10.00 ea
11A-17908	2 1/2" long	17.50 ea
21A-17908	angled	not.avbl

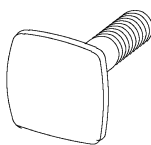

1932-47 Truck 1942-47 Pickup Bumpers

Bumper Face Bar

21C-17757-S	Stainless: w/holes for bolts	not.avbl
21C-17757-HR	Stainless, smoothie, with mount studs	not.avbl

Bumper Bolt

BB-17758-SS	Stainless	10.00 ea
-------------	-----------	----------

1948-56 Pickup Bumpers

Front Bumpers

1948-52 Smooth face, plain (with brackets):

7C-17750-A	170.00 ea
------------	-----------

1948-52 Smooth face, Stainless (w/bkts)

7C-17750-SS	400.00 ea
-------------	-----------

1951-52 Ribbed face, Chrome, (no brackets)

1C-17750-A	250.00 ea
------------	-----------

1948-52 Brackets, Stainless

7C-17754-SS	90.00 pr
-------------	----------

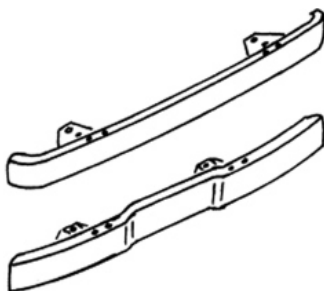

1953-56 Plain

BAAA-17750-B	165.00 ea
--------------	-----------

1953-56 Stainless:

BAAA-17750-SS	400.00 ea
---------------	-----------

Rear Bumpers, 1948-56

1948-56 Smooth Face, Plain

BAAA-17906-A	160.00 ea
--------------	-----------

1951-52 Ribbed Face, Chrome

1C-17906-B	250.00 ea
------------	-----------

1948-56 Smooth Face, Stainless

BAAA-17906-SS	400.00 ea
---------------	-----------

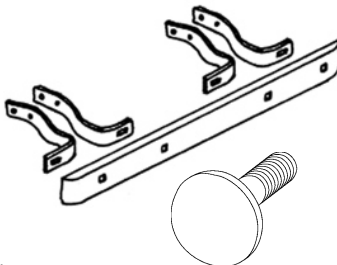

Rear Bumper Brackets

2 left and 2 right brackets are needed for rear bumper.

B5C-17787-S	Rear bumper bkts, 4pc set, 48-56	190.00 set
-------------	----------------------------------	------------

Rear Bumper Face Bolts

BB-17758-SS	Stainless	0.50 ea
-------------	-----------	---------

Custom Bumpers

Classic 5 Rib Style Bumpers

Extruded aluminum and highly polished.
Mounting holes are not drilled, allowing these to fit most years.

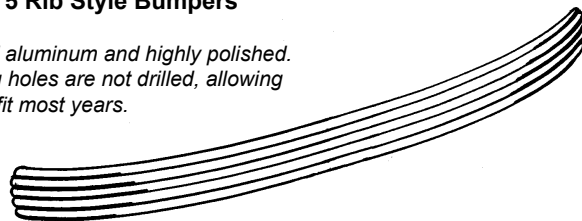

HR-17757-D64F	Flat arc w/curved ends, 64" wide	not.avbl
HR-17757-D64A	1940 Ford arc, 64" wide	not.avbl
HR-17757-D66F	Flat arc w/curved ends, 66" wide	not.avbl
HR-17757-D66A	1940 Ford arc, 66" wide	not.avbl
HR-17757-D68F	Flat arc w/curved ends, 68" wide	not.avbl

1949 Chev Style License Plate Guard

For "DeSoto" 5 rib bumpers, aluminum

HR-17757-CLG	not.avbl
--------------	----------

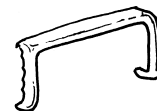

The Custom 3-Rib Style Bumpers

Three-rib style similar to DeSoto style.
Extruded aluminum and highly polished.
These look best on earlier cars such as 1928-34 Fords.

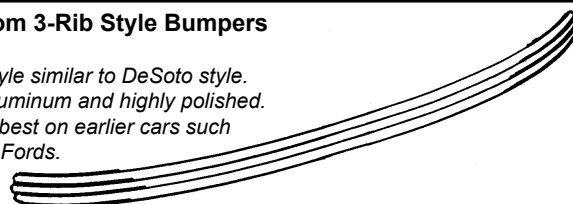

HR-17757-R64F	Flat arc w/curved ends, 64" wide	not.avbl
HR-17757-R64A	1940 Ford arc, 64" wide	not.avbl
HR-17757-R66F	Flat arc w/curved ends, 66" wide	not.avbl
HR-17757-R66A	1940 Ford arc, 66" wide	not.avbl
HR-17757-R68F	Flat arc w/curved ends, 68" wide	not.avbl

Bumper Face Bolt for DeSoto or 3-Rib Bumper

HR-17758-DS	stainless steel	not.avbl
-------------	-----------------	----------

Rear Spare Tire Carrier

Rear Spare Tire Brackets Cast Aluminum

A-1379-A	1928-29 Coupe-Roadster	95.00 ea
A-1380-A	1928-31 Tudor Sedan	95.00 ea
	1928-31 Fordor Phaeton	
A-1379-BA	Aluminum	95.00 ea



Spare Tire Bracket Studs

A-1448	1928-31 Wheel studs	2.50 ea
A-1449	1928-31 Bracket to body studs	5.00 ea

1928-31 Spare Tire Mount Blank Off Kit

For filling the spare tire mount holes in the rear body panel.

A-1380-BO	kit includes 2 large head screws and plug button	10.00 set
-----------	--	-----------

Spare Tire Cover Parts

40-1350	Trim ring: 1933-34 Passenger	not.avbl
48-1350	Trim ring: 1935-36 Passenger	not.avbl
40-1350-S	Cover rubber seal: 1933-36 Passenger	10.00 ea

* Parts with price listed as "not.avbl" are not known to be available at this time, but are listed for reference.