

1928-31 Coupe, Tudor 1930-31 Pickup Door, Window, Deck lid, and Interior

Outside Door Handles:

1928-29 Coupe & Tudor Door

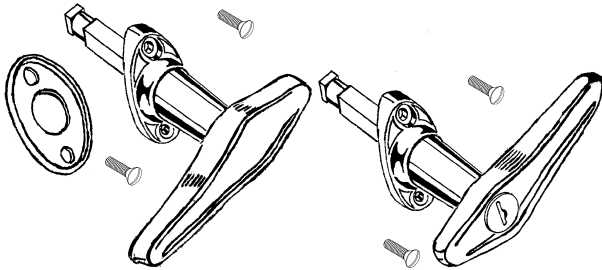

A-702350-AL	RH Handle, locking, diecast, chrome	50.00 ea
A-702351-A	LH Handle, non-locking, diecast, chrome	32.50 ea
A-702350/1-AL	Locking handles w/matching keys note: requires modification to LH door	90.00 ea
A-702356-B	Rubber pads (no bead)	1.50 pr
B-46212-MS	Mounting screws, stainless 3/4" set of 4	2.50 set

Outside Door Handles:

1930-31 Coupe, Tudor & Closed Pickup

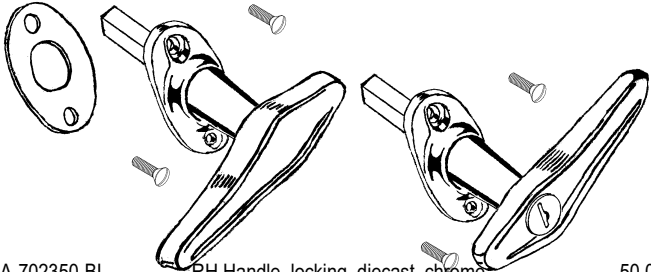

A-702350-BL	RH Handle, locking, diecast, chrome	50.00 ea
A-702351-B	LH Handle, non-locking, diecast, chrome	32.50 ea
A-702350/1-BL	Locking handles with matching keys note: requires modifications to LH door	90.00 ea
B-46212	Rubber pads (with bead)	5.00 pr
A-702356-D	Rubber pads (no bead)	1.50 pr
B-46212-MS	Mounting screws, stainless 3/4" set of 4	2.50 set

Deck Lid Handle: 1928-31 Coupe & Roadster

Locking, w/keys,
mount outside lid.
Die Cast, chrome
plated.
Will fit all 1928-37.

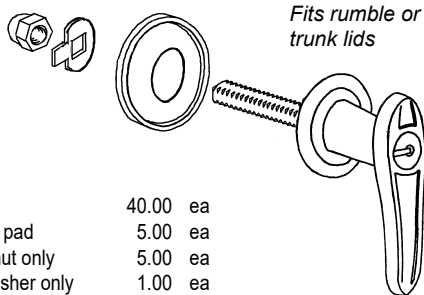

A-702352-A	Handle	40.00 ea
B-41648	Rubber pad	5.00 ea
A-41606-S	Acorn nut only	5.00 ea
A-41606-LW	Lockwasher only	1.00 ea

Inside Door and Window Handles

1928-31 Coupe & Tudor, & 1930-31 Pickup

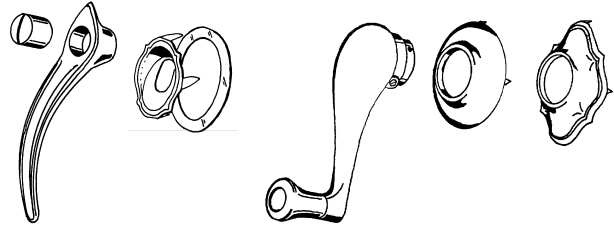

Inside Door Handles

A-702400-AR	1928-29 inside door handle, chrome	7.50 ea
A-702400-A	1930-31 inside door handle, chrome	10.00 ea
A-702400-SN	Sleeve nut, chrome	5.00 ea
A-46270-AR	Escutcheon (Standard style), chrome	10.00 ea
A-46270-B	Escutcheon (Deluxe style), chrome	7.50 ea
A-48140	Dovetail escutcheon for THIN upholstery	5.00 ea

Window riser handle

A-702780-A	Window riser handle, chrome	12.50 ea
A-48200-BR	1931 Coupe back window "T" handle, chrome	27.50 ea
A-46250-P	Handle to shaft pin	0.25 ea
A-48139-A	Escutcheon, standard, chrome	5.00 ea
A-48139-B	Escutcheon, deluxe, chrome	7.50 ea
B-48284	Escutcheon spring (under upholstery)	0.50 ea

Inside Slide Locks & Handles (used on LH door only)

A-46168	Lock assy	15.00 ea
A-46192	Knob, chrome	12.50 ea
A-46272-AR	Escutcheon (Std)	10.00 ea
A-46272	Escutcheon (Dlx)	5.00 ea



1928-56 Panel Truck Back Door Handles

A-702400-C	Chrome plated	10.00 ea
------------	---------------	----------

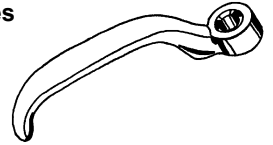

Door & Door Opening Garnish Moldings

1928-31 Coupe & Tudor Sedan & 1930-31 Pickup

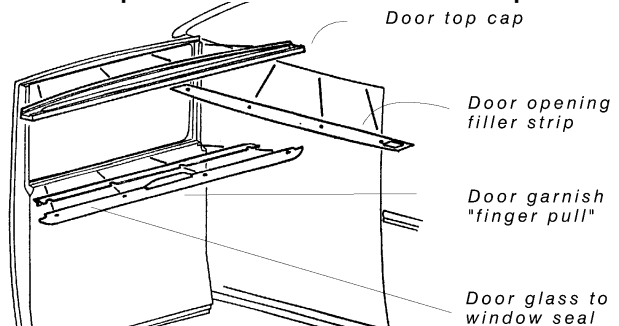

Door "finger pull" garnish moldings:

A-46050-AS	1928-29 Coupe & Tudor	175.00 pr
A-46050-DS	1930-31 Coupe	175.00 pr
A-46050-CS	1930-31 Tudor & Pickup	175.00 pr

Door top cap:

A-45883-A	1928-31 Tudor, 1928-29 Coupe, 1930-31 PU	90.00 ea
A-45883-B	1930-31 Coupe	90.00 ea

Door opening filler strips:

A-45891-AS	1928-31 Tudor, 1928-29 Coupe, 1930-31 PU	45.00 pr
A-45891-BS	1930-31 Coupe	45.00 pr

* Parts with price listed as "not.avbl" are not known to be available at this time, but are listed for reference.

1928-31 Coupe, Tudor 1930-31 Pickup Door, Window, Deck lid, and Interior, cont

1928-31 Window Garnish Seals & Brackets

Mounts under garnish molding, seals against glass.

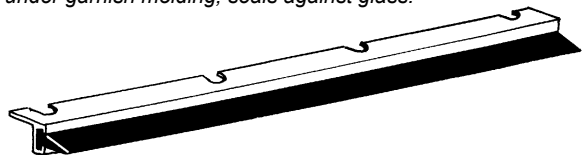

A-19008-A	1928-29 Coupe, 1930-31 Pickup	20.00	pr
A-19008-B	1928-31 Tudor sedan (doors)	20.00	pr
A-19008-C	1928-31 Tudor sedan (quarter windows)	20.00	pr

1928-31 Coupe, Tudor, 30-31 PU Door Garnish Screws

Note: Included in interior trim screw kits when needed.

A-342-S	Door garnish screws	0.50	ea
A-45883-MB	Door top cover screw set	2.00	ea
A-45890-MB	Door opening header screw set	5.00	ea

1928-31 Coupe Quarter Window Garnish Moldings, Fiberglass



CG2829Q	1928-29 Coupe, RH or LH	115.00	ea
CG3031RQ	1930-31 Coupe, RH	115.00	ea
CG3031LQ	1930-31 Coupe, LH	115.00	ea

1928-31 Tudor Sedan Quarter Window Garnish Moldings

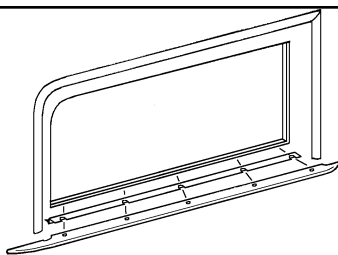

Upper		
A-56051-UQ	not.avbl	
Lower		
A-56050-Q	175.00	pr

1928-31 Coupe & Tudor Back Window Garnish Molding Fiberglass



1928-31 Coupe, Tudor some Fordor Sedans	
RWM2831CS	150.00 ea

1928-31 Pickup Back Window Garnish Moldings



A-83820-AR	1928-29 Pickup, stamped steel	32.50	ea
A-83820-B	1930-31 Pickup, stamped steel	160.00	ea
RWM3034PU	1930-31 Pickup, fiberglass	150.00	ea

Interior Trim Screw Sets

AH-285	1928-29 Sport coupe	20.00	set
AH-286	1928-29 Standard coupe	25.00	set
AH-287	1928-29 Tudor sedan	30.00	set
AH-307	1930-31 Sport coupe	22.50	ea
AH-308	1930-31 Standard coupe	30.00	ea
AH-309	1930-31 Tudor sedan	35.00	ea
AH-314	1930-31 Closed pickup cab	30.00	ea

Typical 1926-31 Coupe, Tudor & Pickup Window Parts

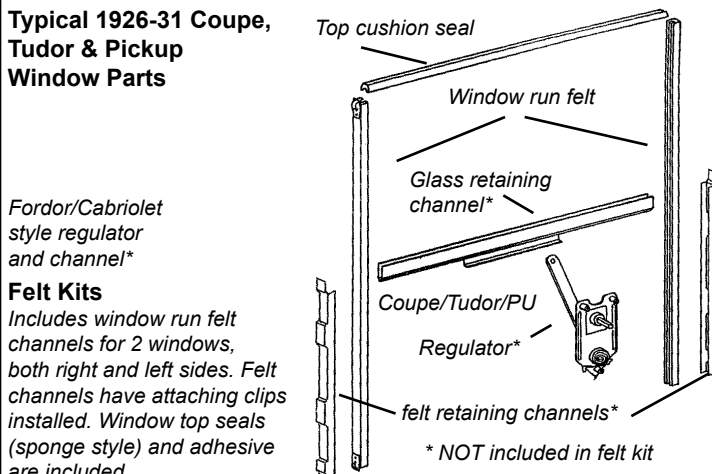

Fordor/Cabriolet style regulator and channel*

Felt Kits

Includes window run felt channels for 2 windows, both right and left sides. Felt channels have attaching clips installed. Window top seals (sponge style) and adhesive are included.

* NOT included in felt kit

A-45983-A	1928-31 Tudor, 1928-29 Coupe, 1930-31 PU	125.00	ea
A-45983-B	1930-31 Coupe	120.00	ea
A-56786	1928-31 Tudor quarter windows	125.00	ea
A-46108	1931 Coupe back window (roll down option)	150.00	ea

Window Glass Top Cushion Only

Sponge style top cushion is included in window felt kits as needed.

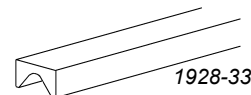

1928-33

A-45983-T	Sponge style, glue in	5.00	ea
-----------	-----------------------	------	----

Regulators and Glass Channel: Coupe, Tudor and Pickup

A-48105-A	Regulator: RH Door and Quarter	65.00	ea
A-48106-A	Regulator: LH Door and Quarter	65.00	ea
A-45962-S	Channel: fits RH or LH	30.00	ea
A-56787	Channel: 1928-31 Tudor Quarter	30.00	ea
B-47106	Channel: 1931 Coupe back window	40.00	ea

Felt Retainer Channels, Coupe, Tudor and Pickup

	RH Front	LH Front	RH Back	LH Back
1928-29 Cpe/Tudor	A-45970-A 17.50 ea	A-45971-A 17.50 ea	A-45970-B 17.50 ea	A-45971-C 17.50 ea
1930-31 Tudor/PU	A-45970-B 17.50 ea	A-45970-C 17.50 ea	A-45972-B 17.50 ea	A-45973-B 17.50 ea
1930-31 Coupes	A-45970-C 17.50 ea	A-45971-A 17.50 ea	A-45972-C 17.50 ea	A-45973-C 17.50 ea

Window Glass to Frame Setting Tape

B-37193-A	all years, 20 ft, 1/32" thick	17.50	ea
B-37193-B	all years, 20 ft, 3/64" thick	17.50	ea
B-37193-C	all years, 20 ft, 1/16" thick	25.00	ea
B-37193-D	all years, 20 ft, 5/64" thick	30.00	ea

Fixed Quarter & Back Window Glass Rubber Channels

1926-36 Coupe & Sedan

B-704220	10'	15.00	ea
----------	-----	-------	----

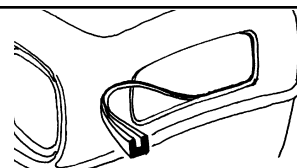

* Parts with price listed as "not.avbl" are not known to be available at this time, but are listed for reference.

1928-31 Coupe, Tudor 1930-31 Pickup Door, Window, Deck lid, and Interior, cont

Door Hinges: 1928-29 Coupe & Tudor

Investment cast steel, hinge pin holes are drilled. Body mount holes are drilled and tapped for 5/16-24 hex bolts. Door mount holes are not drilled, original hinges were riveted to doors.

Cowl side (block)

A-46300-ACU	upper & middle	60.00 ea
A-46300-ACL	lower	75.00 ea

Door side (strap)

A-46300-ADU	upper	60.00 ea
A-46300-ADM	middle	60.00 ea
A-46300-ADL	lower	60.00 ea

Set of 6 hinges with pins

A-46300-AS	set 6	700.00 ea
------------	-------	-----------

Hinge Pins:

A-46335	Hinge Pins, plain	1.00 ea
A-46335-SS	Hinge Pins, Stainless	5.00 ea

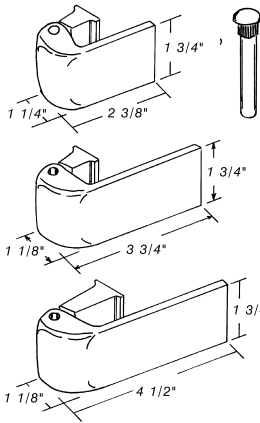

Door Hinges:

1930-31 Coupe Tudor & Pickup 1929-30 Briggs Fordor

Investment cast steel. Hinge pin holes are drilled, Mounting holes not drilled. Original hinges riveted to doors.

Upper Hinge Straps Only

A-46300-BCU	Cowl	60.00 ea
A-46300-BDU	Door	60.00 ea

Middle Hinge Straps Only

A-46300-BCM	Cowl	60.00 ea
A-46300-BDM	Door	60.00 ea

Lower Hinge Straps Only

A-46300-BCL	Cowl	60.00 ea
A-46300-BDL	Door	60.00 ea

Complete Hinge Set,

Set of 6 hinges with pins:

A-46300-BS	700.00 set
------------	------------

Hinge Pins

A-46335	Hinge Pins, plain	1.00 ea
A-46335-SS	Hinge Pins, Stainless	5.00 ea

Hinge Screws

Plain		
1/2" long	B-35600-M050	0.50 ea
3/4" long	B-35600-M075	0.50 ea
1" long	B-35600-M100	2.00 ea
Special washer	B-35600-VVV	1.00 ea

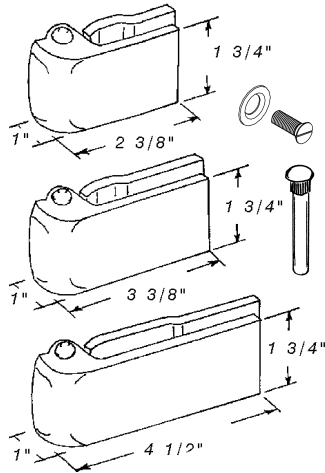

Door Check Straps:

1926-29 Closed Car

Loop Check Straps

A-162592-6	6"	7.50 ea
A-162592-7	7"	7.50 ea
A-162592-8	8"	7.50 ea

Loop check strap bracket:

A-162592-E	1.00 ea
------------	---------

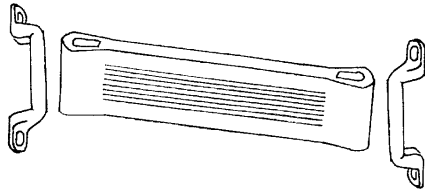

Door Check Arms:

1930-31

Metal Check Arms

A-702828-S	Check arms w/bumpers (replacement style)	15.00 pr
A-702828-BKT	Check arm mount brackets: Front doors	12.50 pr
A-702828-RBKT	Check arm mount Rear doors: Fordor Sedans	25.00 pr
A-702828-PAD	Check arm striker pad (inside body or door)	7.50 pr
A-702828-U	Check arm clip (for original notch type arms)	2.50 ea
A-702828-C	Check arm clip cover	2.50 ea
A-702828-R	Check arm rubber bumper	5.00 pr

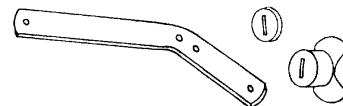

Door Latches: 1928-31 Coupe & Tudor, 1930-31 Pickup

Latches:

A-46105-A	1928-29 RH	55.00 ea
A-46106-A	1928-29 LH	65.00 ea
A-46105-B	1930-31 RH	55.00 ea
A-46106-B	1930-31 LH	65.00 ea
A-46125	Repair kit has springs for both sides	10.00 set

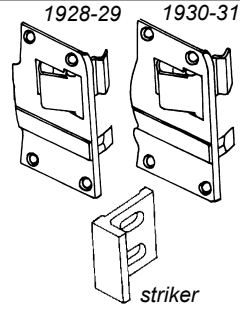

Striker

A-46137	1928-31, plain	5.00 ea
---------	----------------	---------

Inside handle to latch rods (with clips)

A-46158-AS	1928-29 Coupe, 1930-31 Tudor and Pickup	30.00 set
A-46158-BS	1930-31 Coupe	30.00 set
A-46195-S	Clips only (set/4)	10.00 set

Door bumpers and Dovetails

1928-31 Coupe & Tudor, 1930-31 Pickup

Dovetail socket housings are integral with the doors on coupe, tudors and pickups. The rubbers and clips are included with the rubber kits.

Door bumper kits

A-702610-AS	1928-29 Coupe/Tudor	10.00 set
A-702610-BS	1930-31 Coupe/Tudor/Pickup	12.50 set

Dovetail

A-46419-S	Door dovetail	5.00 ea
A-46419-MN	Door dovetail retainer nut	15.00 ea
A-46419-MS	Door dovetail screws	2.00 set

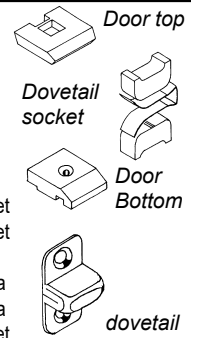

Weather seal: 1926-31 Coupe, Sedan & Pickup

Windlacing was used to seal the front, top, and back of doors. A rubber seal strip was attached under the upholstery at to bottom of door.

Lower Door Seal

A-701980	Front doors use 1 ea, Rear doors 1/2 each	15.00 ea
----------	---	----------

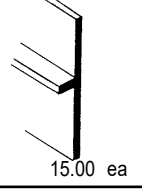

1928-31 Coupe & Tudor Sedan

Door Sill Finish Plates

1928-31 Coupe (8" long)

A-46480-AS	12.50 pr
------------	----------

1928-31 Tudor (19 3/4")

A-46480-BS	20.00 pr
------------	----------

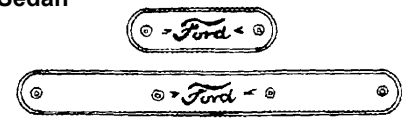

* Parts with price listed as "not.avbl" are not known to be available at this time, but are listed for reference.

1928-31 Coupe, Tudor 1930-31 Pickup Door, Window, Deck lid, and Interior, cont

Trunk Hinges: 1928-32

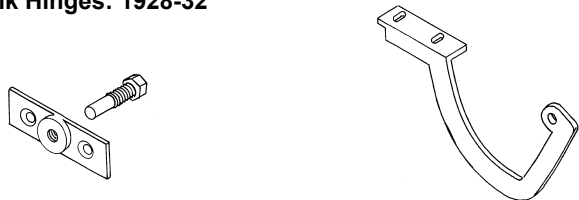

A-41512-S	Original style (pin through upper corner of lid)	27.50	set
B-41513-WT	Wescott lift style, roadster (use AH-1114 pivot)	100.00	pr
B-41513-W3	Wescott lift style, coupe (use AH-1114 pivot)	100.00	pr

Trunk Prop

A-41530	Prop Arm	27.50	ea
A-41530-MB	Shoulder bolt	5.00	ea

Rumble Hinges

Hinge kit includes hinge arms, mount brackets, and pivot bolts

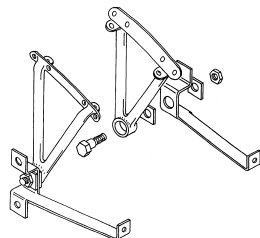

A-41542-S	Hinge kit	95.00	set
AH-1114	Pivot bolt kit	7.50	set

Deck Lid Latch: 1928-32 Roadster

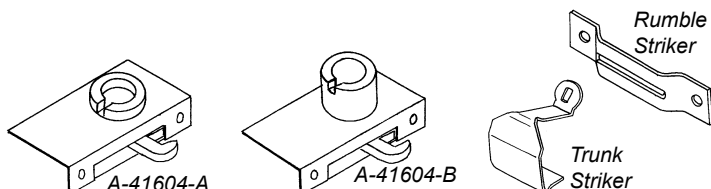

A-41604-A	Latch: 1928-29 Rumble/Trunk, 1928-32 Trunk	100.00	ea
A-41604-B	Latch: 1930-32 Rumble	100.00	ea
A-52500	Striker: 1928-32 Rumble	5.00	ea
B-41615	Striker: 1928-32 Trunk	7.50	ea

Deck Lid Bumpers and Stops:

Round bumpers used upper on rumble and lower on trunk

B-41518	Round Bumper	7.50	pr
---------	--------------	------	----

Rumble Stop with bumpers

A-41585-AS	Bkt kit: 1928-29	32.50	ea
A-41585-BS	Bkt kit: 1930-31	not.avbl	
B-41484	Bumpers	7.50	pr

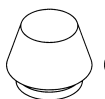

* Parts with price listed as "not.avbl" are not known to be available at this time, but are listed for reference.