

1928-31 Fordor, Cabriolet, and Victoria Door, Window, Deck lid, and Interior, cont

Outside Door Handles:

1928-30 (Straight Windshield) Fordor & Cabriolet

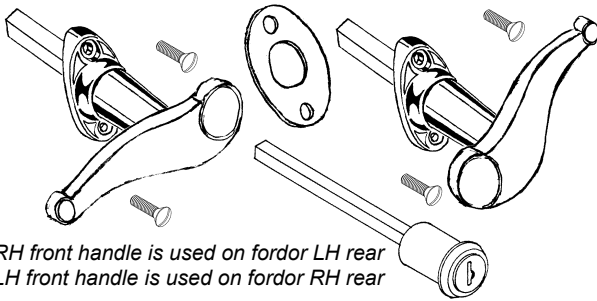

*RH front handle is used on fordor LH rear
LH front handle is used on fordor RH rear*

A-702350-C	RH Front Handle, non-locking, diecast chrome	60.00 ea
A-702351-C	LH Front Handle, non-locking, diecast chrome	60.00 ea
A-702356-C	Rubber pads (no bead)	1.00 pr
B-46212-WS	Mount screws, Chrome for wood, set of 4	2.50 set
B-41650	Key Cylinder (Briggs & Stratton replacement)	17.50 ea

Door Handles:

1930-31 (Slant Windshield) Fordor Cabriolet Victoria

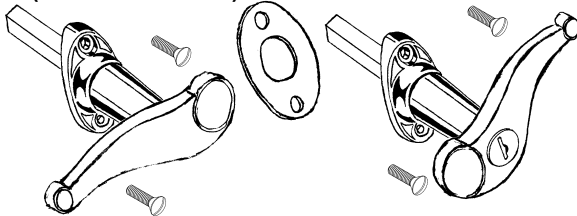

A-702350-DL	RH Front Handle, locking, diecast, chrome	75.00 ea
A-702350-D	Fordor LH rear Handle, non-locking, chrome	70.00 ea
A-702351-D	LH Front Handle, non-locking, diecast chrome	70.00 ea
	RH Rear Handle	
B-46212	Rubber pads (with bead)	5.00 pr
A-702356-D	Rubber pads (no bead)	1.50 pr
B-46212-MS	Mounting screws, stainless 3/4" set of 4	2.50 set

Deck Lid Handle: Cabriolet

*Locking, w/keys,
mount outside lid.
Die Cast, chrome
plated.
Will fit 1928-37.*

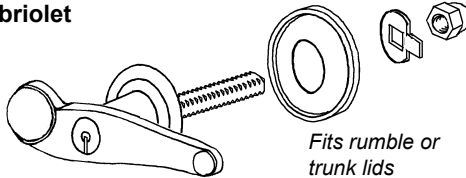

*Fits rumble or
trunk lids*

A-702352-A	Handle	40.00 ea
B-41648	Rubber pad	5.00 ea
A-41606-S	Acorn nut only	5.00 ea
A-41606-LW	Lockwasher only	1.00 ea

Inside Handles: 1928-30 Fordor & Cabriolet "Scroll Style"

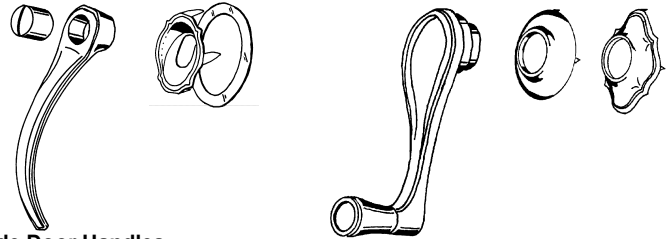

Inside Door Handles

A-702400-B	Inside door handle	10.00 ea
A-702400-SN	Sleeve nut	5.00 ea
A-46270-B	Escutcheon	7.50 ea
A-48140	Dovetail escutcheon for THIN upholstery	5.00 ea

Window riser handle, chrome plated

A-702780-B	Window riser handle	15.00 ea
A-48200-BR	Fordor quarter window "T" handle	27.50 ea
A-46250-P	Handle to shaft pin	0.25 ea
A-48139-A	Escutcheon, standard	5.00 ea
A-48139-B	Escutcheon, deluxe	7.50 ea
B-48284	Escutcheon spring (under upholstery)	0.50 ea

Door Lock Inside Turn Knob, Chrome Plated

A-61148-CR	Fordor LF and rear doors	12.50 ea
------------	--------------------------	----------

1930-31 Victoria

**1931 (Slant windshield)
Fordor Sedan & Cabriolet**

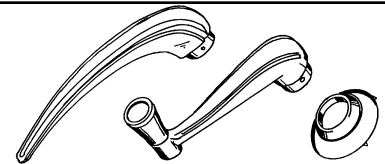

A-702400-V	Inside door handle, chrome	10.00 ea
A-702780-V	Door window riser handle, chrome	15.00 ea
A-48200-BR	Fordor quarter window "T" handle, chrome	27.50 ea
A-46250-P	Handle to shaft pin	0.25 ea
B-48139-C	Escutcheon, stainless	10.00 ea
B-48284	Escutcheon spring (under upholstery)	0.50 ea

Arm Rest Former

A-56666-PR	Rear seat, 1930-34 Sedan	70.00 pr
------------	--------------------------	----------

Window Garnish Seals & Brackets

Mounts under garnish molding, seals against glass.

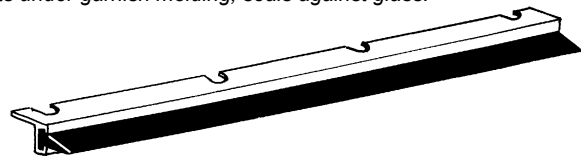

A-119008-4DF	1928-30 Fordor (front door) and Cabriolet	17.50 ea
A-19008-4DR	1928-30 Fordor (rear doors)	17.50 ea

Finger Pulls on Garnish, Chrome Plated

A-61062-CR	1928-30 Cabriolet & Fordor sedan	30.00 ea
------------	----------------------------------	----------

1930-31 Victoria Door Header Panels

The panels on the body above door.

	RH		LH	
Cloth back victorias	A-45891-VCR	300.00 ea	A-45891-VCL	300.00 ea
Steel back victorias	A-45891-VSR	140.00 ea	A-45891-VSL	140.00 ea

* Parts with price listed as "not.avbl" are not known to be available at this time, but are listed for reference.

1928-31 Fordor, Cabriolet, and Victoria Door, Window, Deck lid, and Interior, cont

1930-31 Victoria Window Garnish Moldings

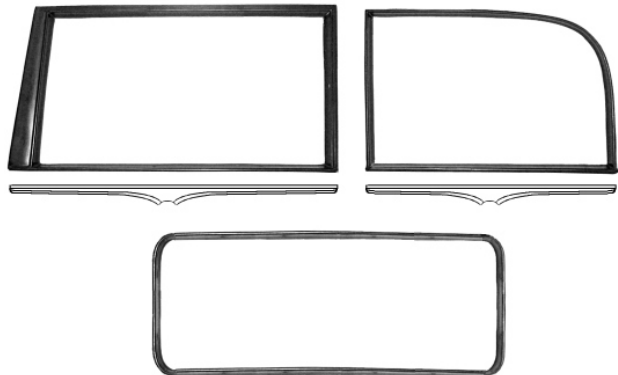

	RH		LH	
Door window, 'glas	CG3031VDR	not.avbl	CG3031VDL	not.avbl
Door lower trim, steel	A-542-BVR	190.00 ea	A-542-BVL	190.00 ea
Quarter window, 'glas	CG3031VQR	not.avbl	CG3031VQL	not.avbl
Quarter trim, steel	A-542-BVQ	165.00 ea	A-542-BVQ	165.00 ea
RWM3031V	Back window frame, fiberglass			not.avbl

1931 Fordor Sedan Door Window Garnish Lower Trim

A-542-BFD	1931 Fordor ft door: RH or LH	165.00 ea
A-542-BRD	1931 Fordor rear door: RH or LH	165.00 ea
A-542-BQ	1931 Fordor quarter: RH or LH	150.00 ea

Door Window Garnish Molding Tube Nut Sets

Note: Included in interior trim screw kits when needed.

AH-1102	8-32, set of 10, 1931 Slant Windshield	0.50 ea
AH-1103	6-32, set of 6, 1928-30 Briggs Fordor	0.50 ea

Interior Trim Screw Sets

AH-280	1928-29 Briggs 4D w/o qtr window	55.00 set
AH-281	1928-29 Briggs 4D w/qtr window	60.00 set
AH-282	1928-29 Murray Fordor sedan	75.00 set
AH-289	1928-29 Cabriolet	35.00 set
AH-300	1930-31 Briggs Fordor sedan	80.00 ea
AH-301	1930-31 Murray Fordor sedan	80.00 ea
AH-302	1930-31 Slant windshield, Fordor	45.00 ea
AH-310	1931 Slant windshield, Cabriolet	50.00 ea
AH-311	1930-31 Victoria	45.00 ea
AH-312	1931 A-400 Convertible sedan	30.00 ea
AH-313	1930-31 Cabriolet (68-B)	35.00 ea

Typical 1926-30 Fordor Window Parts

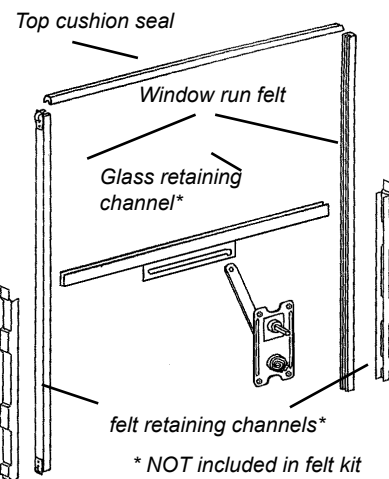

Felt Kits

Includes window run felt channels for 2 windows, both right and left sides. Felt channels have attaching clips installed. Window top seals (sponge style) and adhesive are included.

A-45983-4D	1928-30 Fordor front doors	120.00 ea
A-56791-A	1928-30 Fordor rear doors	80.00 ea

Window Glass Top Cushion Only

Sponge style top cushion is included in window felt kits as needed.

1928-33

A-45983-T	Sponge style, glue in	5.00 ea
-----------	-----------------------	---------

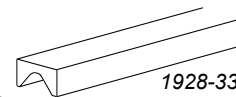

Regulators and Glass Channel: 1928-30 Fordor & Cabriolet

A-48105-B	Regulator: RH front door, LH rear door	50.00 ea
A-48106-B	Regulator: LH front door, RH rear door	50.00 ea
A-45963-A	Channel: RH front door, LH rear door	10.00 ea
A-45963-B	Channel: LH front door, RH rear door	10.00 ea

Felt Retainer Channels: 1928-30 Fordor

A-45970-DF	Front door, front or back, 1929-30 Fordor	27.50 ea
A-45970-DR	Rear door, front or back, 1929-30 Fordor	22.50 ea

* Parts with price listed as "not.avbl" are not known to be available at this time, but are listed for reference.

1928-31 Fordor, Cabriolet, and Victoria Door, Window, Deck lid, and Interior, cont

Typical 1930-31 Victoria and 1931 Fordor Window Parts

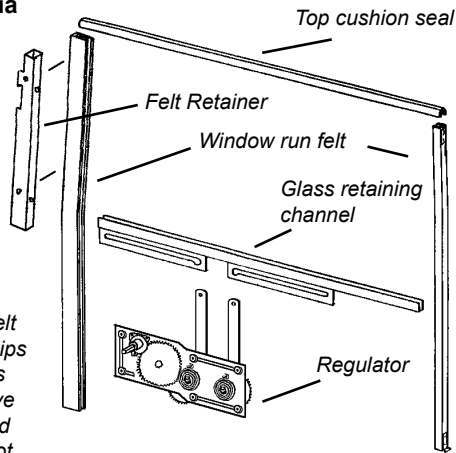

Felt Kits

Includes window run felt channels for 2 windows, both right and left sides. Felt channels have attaching clips installed. Window top seals (sponge style) and adhesive are included. Regulator and glass retaining channels not included.

A-45983-V	1931 Victoria & Fordor front doors	120.00 ea
B-56786-V	1930-31 Victoria quarter windows	95.00 ea
A-56791-B	1931 Fordor rear door & quarter	85.00 ea

Felt Retainer

Used on front doors, retains felt and garnish molding attaches to this.

A-45985-R	RH, Victoria, Fordor front door, and A-400	175.00 ea
A-45985-L	LH, Victoria, Fordor front door, and A-400	175.00 ea

Window Glass Bottom Retaining Channels

B-45962	Door, RH or LH front: 1931 Fordor	50.00 ea
B-55962	Door, RH front: 1930-31 Victoria	55.00 ea
B-55963	Door, LH front: 1930-31 Victoria	55.00 ea
46-45963	Rear door, RH: 1931 Fordor (shorten to fit)	40.00 ea
46-45962	Rear door, LH: 1931 Fordor (shorten to fit)	40.00 ea
A-45963-A	Quarter RH: Victoria, 1931 Fordor (shorten to fit)	10.00 ea
A-45963-B	Quarter LH: Victoria, 1931 Fordor (shorten to fit)	10.00 ea

Window Glass to Setting Channel with Body Seal

Fordor sedan, Victoria, & Cabriolet
Sets glass into channel. When window is rolled up it is sealed to door or body. 6' length.

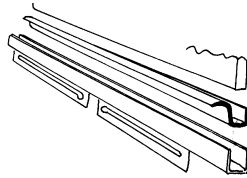

B-45968	10.00 ea
---------	----------

Window Glass to Frame Setting Tape

B-37193-A	all years, 20 ft, 1/32" thick	17.50 ea
B-37193-B	all years, 20 ft, 3/64" thick	17.50 ea
B-37193-C	all years, 20 ft, 1/16" thick	25.00 ea
B-37193-D	all years, 20 ft, 5/64" thick	30.00 ea

Fixed Quarter & Back Window Glass Rubber Channels

1926-36 Coupe & Sedan

B-704220	10'	15.00 ea
----------	-----	----------

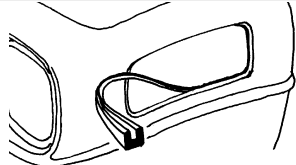

Door Hinges: 1930-31 Victoria 1931 Slant Windshield Fordor

Investment cast steel.
Drilled for pins.
Not drilled for mounting.
Original hinges riveted to door

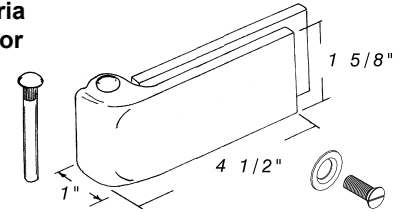

Hinge Straps:

B-35600-CUL	Front hinge body upper, door lower; Rear hinge body	60.00 ea
B-35600-DUL	Front hinge body lower, door upper; Rear hinge door	60.00 ea

Hinge Pins

B-35615	Hinge pin, plain	not.avbl
B-46335-SS	Hinge pin, stainless (cut to length)	5.00 ea

Hinge Screws

	Plain	Chrome
1" long	B-35600-M100 2.00 ea	B-35600-M100C 10.00 ea
Special washer	B-35600-WW 1.00 ea	B-35600-WWC 7.50 ea

Door Check Arms: 1930-31

Metal Check Arms

A-702828-S	Check arms w/bumpers (replacement style)	15.00 pr
A-702828-BKT	Check arm mount brackets: Front doors	12.50 pr
A-702828-RBKT	Check arm mount Rear doors: Fordor Sedans	25.00 pr
A-702828-PAD	Check arm striker pad (inside body or door)	7.50 pr
A-702828-U	Check arm clip (for original notch type arms)	2.50 ea
A-702828-C	Check arm clip cover	2.50 ea
A-702828-R	Check arm rubber bumper	5.00 pr

Rubber Door Check Straps, "T" Style

Used on 1931-32 Fordor rear doors,

B-162592-T	Check strap	7.50 ea
B-162592-S	Clamp bracket	5.00 ea



Door Latches: 1929-30 Fordor and Cabriolet

Complete latch assemblies are not reproduced.

Latch Spring Replacement Kits:

A-46125-BL	Spring kit LF/RR "diamond"	100.00 ea
A-46125-BR	Spring kit RF/LR "diamond"	100.00 ea
A-46125-ML	Spring kit LF/RR "swis"	105.00 ea
A-46125-MR	Spring kit RF/LR "swis"	105.00 ea

Door Striker Plates:

1929-30 Fordor and Cabriolet

A-61135-AR	Briggs Fordor Sedans	20.00 ea
A-156135	Murray Fordor Sedan	20.00 ea
A-69135-R	Cabriolet	25.00 ea

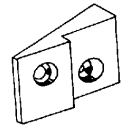

Door Latches: 1930-31 Victoria, 1931 Fordor and Cabriolet

Door Latch* w/inside handle mount**:

B-46105-B	RH front, LH rear	300.00 ea
B-46106-B	LH front, RH rear	300.00 ea

* Remove key lock mechanism for 1930-31 and 1931-32 rear doors.

** Inside handle link length is for 1932 5W and 4D front, modify for others.

** Latch requires minor modification for 1930-31.

Door latch repair parts:

Door latch spiral spring:		
B-46125	5.00 ea	
Inside Handle Mount spring:		
B-702268	5.00 ea	

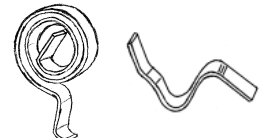

* Parts with price listed as "not.avbl" are not known to be available at this time, but are listed for reference.

1928-31 Fordor, Cabriolet, and Victoria Door, Window, Deck lid, and Interior, cont

Door Striker Plates: 1930-31 Victoria, 1931 Fordor & Cabriolet

A-156135	Plain: Victoria/A-400	20.00	ea
B-46137-A	Plain: Fordor	15.00	ea
40-702340-SS	Stainless: Fordor	17.50	ea

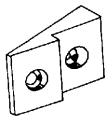

Latch Striker Nut Plate:

48-702336-A	Fordor	17.50	pr
-------------	--------	-------	----

Door Dovetails & Bumpers:

1929-30 Fordor and Cabriolet

Door Bumper Kits

A-702610-CS	Fordor sedan	15.00	set
A-702610-HS	Cabriolet	10.00	set

Dovetail:

A-61419-A	Dovetail, (6 mt holes)	17.50	ea
A-61412	Socket (4 mt hole)	20.00	ea

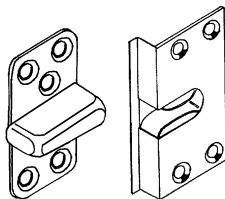

Doors Bumpers and Dovetails:

1930-31 Victoria, 1931 Fordor & Cabriolet

Door Bumpers:

B-46440	Fordor	1.50	ea
B-191442	Victoria & Cabriolet	2.50	ea
A-702610-68	Cabriolet (upper)	12.50	ea

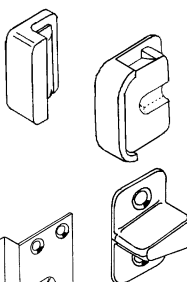

Door Male Dovetails:

B-46421	Dovetail, stainless	7.50	ea
B-46421-S	mounting screws	2.50	set

Door Dovetail Sockets:

A-61412-C	Victoria, Cabriolet	55.00	ea
-----------	---------------------	-------	----

1931 Fordor Sedan:

48-702574-RK	Socket repair kit	15.00	ea
--------------	-------------------	-------	----

1928-31 Cabriolet, Fordor & Victoria Door Sill Plates

A-46480-CS	1928-29 Briggs fordor front	60.00	pr
A-46481-CS	1928-29 Briggs fordor rear	45.00	pr
A-46480-MS	1930 Murray fordor front & rear	190.00	set
A-46480-SS	1931 S/W fordor, front & rear	165.00	set
A-46480-SWC	1931 S/W Cabriolet	110.00	pr
A-46480-V	1930-31 Victoria	185.00	pr

Weather seal: 1928-31

Windlacing was used to seal the front, top, and back of doors. A rubber seal strip was attached under the upholstery at to bottom of door.



Lower Door Seal

A-701980	Front doors use 1 ea, Rear doors 1/2 each	15.00	ea
----------	-------------------------------------------	-------	----

Trunk Hinges: 1928-32

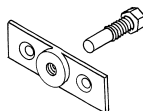

A-41512-S	Original style (pin through upper corner of lid)	27.50	set
B-41513-WT	Wescott lift style, roadster (use AH-1114 pivot)	100.00	pr
B-41513-W3	Wescott lift style, coupe (use AH-1114 pivot)	100.00	pr

Trunk Prop

A-41530	Prop Arm	27.50	ea
A-41530-MB	Shoulder bolt	5.00	ea

Rumble Hinges

Hinge kit includes hinge arms, mount brackets, and pivot bolts

A-41542-S	Hinge kit	95.00	set
AH-1114	Pivot bolt kit	7.50	set

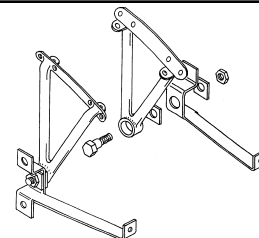

Deck Lid Latch: 1928-32 Roadster

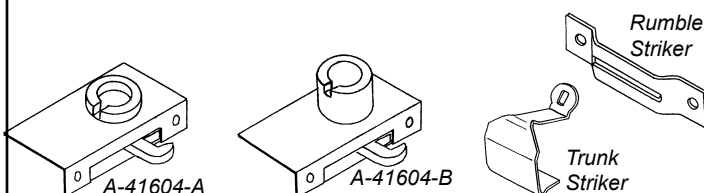

A-41604-A	Latch: 1928-29 Rumble/Trunk, 1928-32 Trunk	100.00	ea
A-41604-B	Latch: 1930-32 Rumble	100.00	ea
A-52500	Striker: 1928-32 Rumble	5.00	ea
B-41615	Striker: 1928-32 Trunk	7.50	ea

Deck Lid Bumpers and Stops:

Round bumpers used upper on rumble and lower on trunk

B-41518	Round Bumper	7.50	pr
---------	--------------	------	----

Rumble Stop with bumpers

A-41585-AS	Bkt kit: 1928-29	32.50	ea
A-41585-BS	Bkt kit: 1930-31 not.avbl		
B-41484	Bumpers	7.50	pr

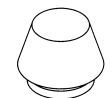

* Parts with price listed as "not.avbl" are not known to be available at this time, but are listed for reference.