

1932 Coupes, Sedans, Victoria, Cabriolet Door, Window, Deck Lid, and Interior

Outsied Handle: 1932 Sedan, 5 Window Coupe, & Victoria

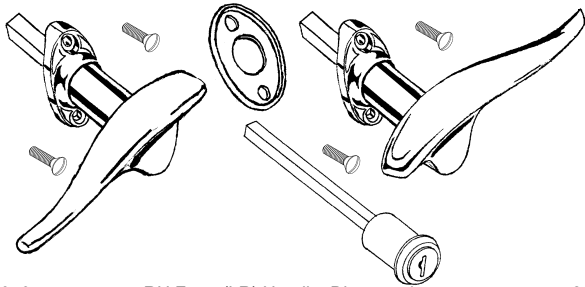

B-702350	RH Front (LR) Handle, Diecast, chrome	25.00 ea
B-702351	LH Front (RR) Handle, Diecast, chrome	27.50 ea
B-702350/1	RH & LH Handles, stainless clad as original	150.00 pr
B-46212	Rubber pads (with bead)	5.00 pr
B-46212-MS	Mounting screws, stainless 3/4" set of 4	2.50 set
B-41650	Key Cylinder (Briggs & Stratton replacement)	17.50 ea

Outside Handle: 1932 3 Window & Cabriolet

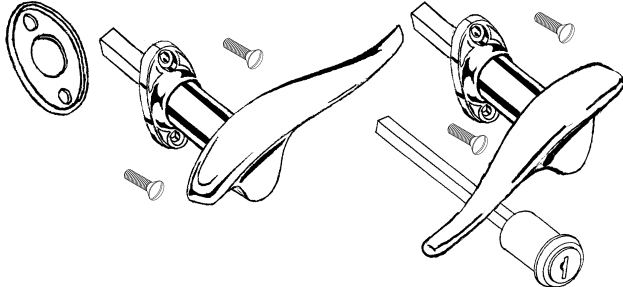

40-702350	RH Front (LR) Handle, nonlock, chrome	32.50 ea
40-702351	LH Front (RR) Handle, nonlock, chrome	32.50 ea
40-702350/1-L	RH & LH Handles, locking, diecast chrome	100.00 pr
40-702350/1	RH & LH Handles, nonlock, stainless clad	not.avbl
B-46212	Rubber pads (with bead)	5.00 pr
B-46212-MS	Mounting screws, stainless 3/4" set of 4	2.50 set
B-41650	Key Cylinder (Briggs & Stratton replacement)	17.50 ea

1932 Deck Lid Handle: Rumble or Trunk

*Locking, w/keys
Die Cast, chrome
plated. Will fit 1928-37.*

40-702352	Handle	50.00 ea
B-41648	Rubber pad	5.00 ea
A-41606-S	Acorn nut only	5.00 ea
A-41606-LW	Lockwasher only	1.00 ea

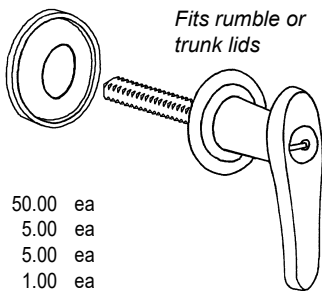

*Fits rumble or
trunk lids*

Inside Door Handles

1932 Closed Passenger

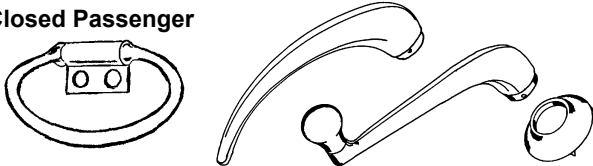

B-702400-ES	Inside door handle, chrome	10.00 ea
B-702780-ES	Window riser handle, chrome	12.50 ea
A-48200-BR	Back & quarter window "T" handle, chrome	27.50 ea
A-46250-P	Handle to shaft pin	0.25 ea
B-48139-C	Escutcheon, chrome	10.00 ea
B-48284	Escutchion spring (under upholstery)	0.50 ea
40-702420-A	Closer ring, stainless, 3 Window only	50.00 pr

Arm Rest Formers

A-56665-PR	Front door, 1932-48 Passenger	95.00 pr
A-56666-PR	Rear seat, 1930-34 Sedan	70.00 pr

Window Garnish Moldings: 1932 5-Window Coupe

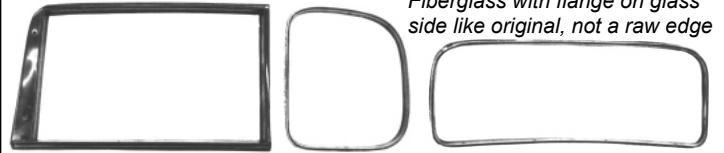

*Fiberglass with flange on glass
side like original, not a raw edge*

CG32W5R	Door window: RH	285.00 ea
CG32W5L	Door window: LH	285.00 ea
CG32W5QR	Quarter window: RH	230.00 ea
CG32W5QL	Quarter window: LH	230.00 ea
RWM32W5	Back window	230.00 ea

Window Garnish Moldings, 1932 3-Window Coupe



*Fiberglass with
flange on glass
side like original,
not a raw edge*

CG32W3R	Door window garnish, RH	315.00 ea
CG32W3L	Door window garnish, LH	315.00 ea
RWM32W3	Back window garnish	230.00 ea

1932 Tudor Sedan Garnish Moldings (Fiberglass)

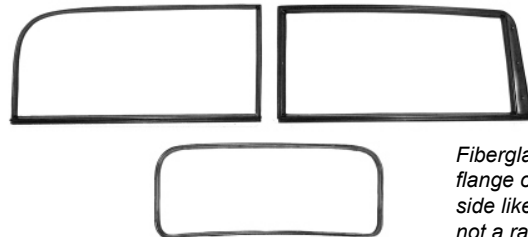

*Fiberglass with
flange on glass
side like original,
not a raw edge*

CG32S2R	Door window garnish, RH	315.00 ea
CG32S2L	Door window garnish, LH	315.00 ea
CG32S2QR	Quarter window garnish, RH	315.00 ea
CG32S2QL	Quarter window garnish, LH	315.00 ea
RWM32S	Back window garnish	230.00 ea

Fixed Quarter & Back Window Glass Rubber Channels

Quarter & Back Window Seal

10' length.
B-704220 15.00 ea

5-Window Quarter Window Seal

Ends seamed as original.
B-704220-S 20.00 pr

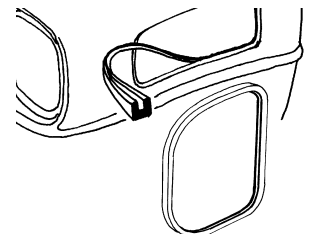

* Parts with price listed as "not.avbl" are not known to be available at this time, but are listed for reference.

1932 Coupes, Sedans, Victoria, Cabriolet Door, Window, Deck Lid, and Interior, cont

Typical 1932 Coupe & Sedan Window Parts

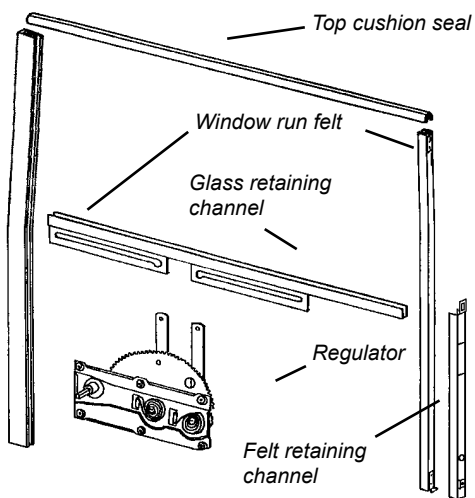

Felt Kits

Includes window run felt channels for 2 windows, both right and left sides. Felt channels have attaching clips installed. Window top seals (sponge style) and adhesive are included. Regulator and glass retaining channels not included.

B-45983-3W	3-Window coupe doors	125.00 ea
B-45983-5W	5-Window, Tudor Sedan, Fordor (front)	125.00 ea
B-45983-V	Victoria doors	95.00 ea
B-56786	Tudor sedan quarter windows	115.00 ea
B-56786-V	Victoria quarter windows	95.00 ea
B-56786-400	Conv. sedan (B-400) quarter windows	95.00 ea
B-56791	Fordor rear doors & quarters	125.00 ea
A-46108	Coupe roll down back window	55.00 ea

Window Glass Top Cushion Only

A-45983-T	1 required per window, included in kits	5.00 ea
-----------	---	---------

1932 Window Regulators

18-702700	RF door: 1932 Coupe, Sedan, Victoria	175.00 ea
18-702701	LF door: 1932 Coupe, Sedan, Victoria	175.00 ea
A-48105-B	RH Quarter window: 1932 Victoria	50.00 ea
A-48106-B	LH Quarter window: 1932 Victoria	50.00 ea

Glass Retaining Channels

B-45962	Door, RH or LH: 5-Window & Fordor (front)	50.00 ea
B-55962	Door, RH: Tudor & Victoria	55.00 ea
B-55963	Door, LH: Tudor & Victoria	55.00 ea
18-45962	Door, RH: 3-Window coupe	55.00 ea
18-45963	Door, LH: 3-Window coupe	55.00 ea
46-45963	Rear Door, RH: Fordor (shorten to fit)	40.00 ea
46-45962	Rear Door, LH: Fordor (shorten to fit)	40.00 ea
B-56787-A	Quarter: RH: Tudor	50.00 ea
B-56788-A	Quarter: LH: Tudor	50.00 ea
46-45962	Quarter: RH: Victoria & Fordor (shorten to fit)	40.00 ea
46-45963	Quarter: LH: Victoria & Fordor (shorten to fit)	40.00 ea
B-47106	Back Window: 1930-34 Coupe (roll down)	40.00 ea

Felt retaining Channel

B-45970	Door back, RH or LH: 5-Window & Sedans	30.00 ea
---------	--	----------

Window Glass to Body Seal

Sets glass into channel. When window is rolled up it is sealed to door or body. 6' length

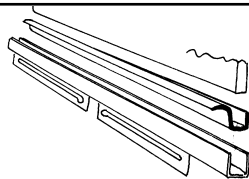

B-45968	10.00 ea
---------	----------

Door Hinges: 1932 3-Window

Investment cast steel Drilled for hinge pin only. Mounting holes not drilled. Trim hinges to fit.

Hinge Straps:

Upper RH (Body) Hinge Strap:		
B-523200-C	100.00 ea	
Upper RH (Door) Hinge Strap:		
B-523200-D	100.00 ea	
Upper LH (Body) Hinge Strap:		
B-523201-C	100.00 ea	
Upper LH (Body) Hinge Strap:		
B-523201-D	100.00 ea	
Center Hinge (Body) Straps:		
B-523202-C	65.00 ea	
Center Hinge (Door) Straps:		
B-523202-D	65.00 ea	
Lower Hinge (Body) Straps:		
B-523204-C	80.00 ea	
Lower Hinge (Door) Straps:		
B-523204-D	80.00 ea	

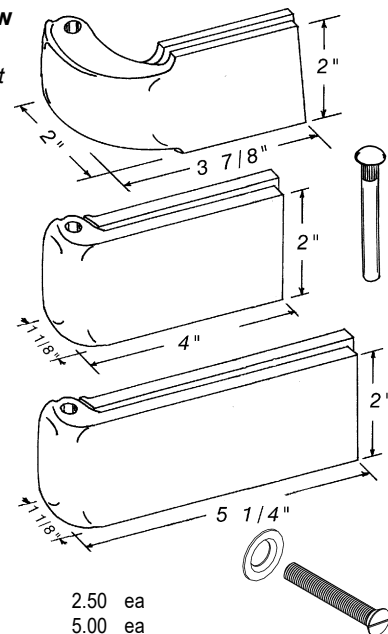

Hinge Pins

B-46335	plain	2.50 ea
B-46335-SS	stainless	5.00 ea

Hinge to body mounting

B-35600-M300	Screw (3" long)	5.00 ea
B-35600-WW	Washer	1.00 ea

Door Hinges: 1932 5 Window, Tudor, Victoria, Cabriolet

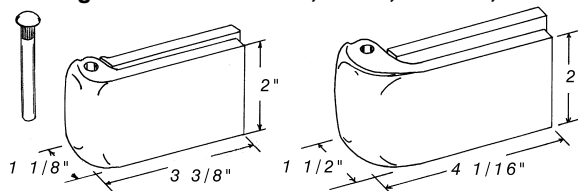

Investment cast steel. Drilled for hinge pin only. Mounting holes are not drilled. Original hinges riveted to doors.

	Upper Hinge		Lower Hinge	
Body strap	B-46300-CU	not.avbl	B-46300-CL	65.00 ea
Door strap	B-46300-DU	not.avbl	B-46300-DL	65.00 ea
Hinge Pins	Plain		Stainless	
standard length	B-46335	2.50 ea	B-46335-SS	5.00 ea
extra long for mirror			B-46335-XS	5.00 ea
Hinge to body screws				
B-35600-M100	1" long			2.00 ea
B-35600-WW	Washer			1.00 ea

Door Check Arms:

Metal check arms, Front doors
5 Window, sedans, Victoria, cabriolet

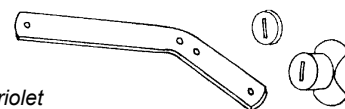

A-702828-S	Check arms w/bumpers (replacement style)	15.00 pr
A-702828-BKT	Check arm mount brackets: Front doors	12.50 pr
A-702828-PAD	Check arm striker pad (inside body or door)	7.50 pr
A-702828-U	Check arm clip (for original notch type arms)	2.50 ea
A-702828-C	Check arm clip cover	2.50 ea
A-702828-R	Check arm rubber bumper	5.00 pr

Rubber Door Check Straps, "T" Style

3 Window doors and Fordor rear doors,

B-162592-T	Check strap	7.50 ea
B-162592-S	Clamp bracket	5.00 ea

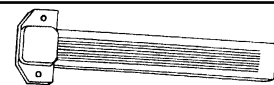

* Parts with price listed as "not.avbl" are not known to be available at this time, but are listed for reference.

1932 Coupes, Sedans, Victoria, Cabriolet Door, Window, Deck Lid, and Interior, cont

Door Latches: 5 Window, Sedans & Cabriolet

Door Latch* w/inside handle mount**:

B-46105-B	RH front, LH rear	300.00 ea
B-46106-B	LH front, RH rear	300.00 ea

* Remove key lock mechanism for rear doors.

**Inside handle link length is for 1932 5W and 4D front, modify for others.

Door Latch 1932 3 Window

Door Latch:

B-522800	Door latch, RH	375.00 ea
B-522801	Door latch, LH	375.00 ea

Door Latch Repair Parts

3 & 5 Window, Sedans, Victoria, Cabriolet

B-46125	Spiral spring	5.00 ea
B-702268	Inside handle spring	5.00 ea

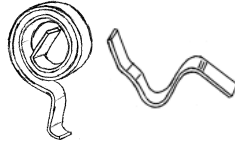

Door Latch Striker

5 Window, Sedans, Victoria:

B-46137-A	Plain:	15.00 ea
40-702340-SS	Stainless:	17.50 ea
48-702336-A	nut plate:	17.50 pr

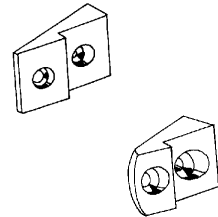

Cabriolet

B-62433	Plain	not.avbl
---------	-------	----------

3 Window

B-46137-B	Plain	12.50 ea
-----------	-------	----------

Door Bumpers:

3 and 5 Window, Tudor and Fordor

B-46440	1.50 ea
---------	---------

Victoria, Cabriolet, rear door Delivery

B-191442	2.50 ea
----------	---------

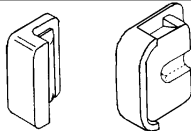

Door Dovetails:

B-46421	Dovetail, stainless	15.00 ea
B-46421-ADJ	Dovetail, adjustable	25.00 ea
B-46421-S	Mounting screws	2.50 set
B-46412-BS	Socket, plain	12.50 ea
B-46412-SS	Socket, stainless	17.50 ea
B-702574-RK	Socket rebuild kit	7.50 ea

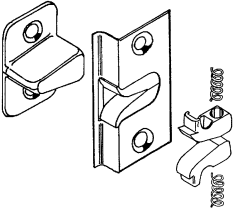

Doors weather seal:

Windlacing was used to seal the front, back, and top (5 Window coupe and sedan) of doors. 3 Window used a rubber seal across the top that inserted into the body panel (most fiberglass bodies cannot use this seal). A rubber seal strip was attached under the upholstery at to bottom of door. Front doors use 1 strip each, rear doors use 1/2 strip.

40-701980	Lower door seal strip	10.00 ea
-----------	-----------------------	----------

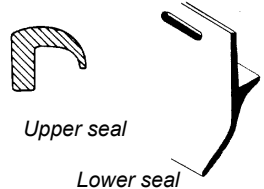

1932 Door Sill Plates

Stainless Steel

B-46480-AS	5-Window coupe & Tudor sedan	100.00 pr
B-46480-BS	3-Window coupe	100.00 pr



Trunk Hinges:

Original style

Pin through upper corner of lid

5 Window & Cabriolet

A-41512-S	27.50 set
-----------	-----------

3 Window

B-41512-3W	125.00 ea
------------	-----------

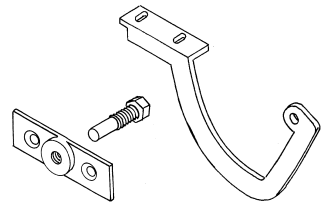

Wescott lift style

Uses AH-1114 pivot bolt

B-41513-WT	Roadster	100.00 pr
------------	----------	-----------

B-41513-W3	Coupe	100.00 pr
------------	-------	-----------



Bumper and Stops:

B-41518	Lower bumper	7.50 pr
---------	--------------	---------

Trunk Prop

A-41530	Prop Arm	27.50 ea
A-41530-MB	Shoulder bolt	5.00 ea

Rumble Hinges, Roadster/5Window/Cabriolet style

Includes cast aluminum hinge arms, mount brackets, and pivot bolts

B-41542-S	Roadster	400.00 set
B-47542-S	5 Window	not.avbl
B-63572-S	Cabriolet	not.avbl

AH-1114	Pivot bolt kit	7.50 set
---------	----------------	----------

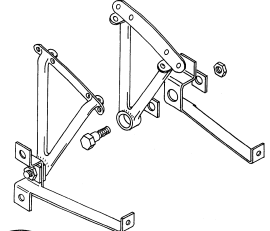

Bumper and Stops:

B-41518	Upper bumper	7.50 pr
---------	--------------	---------

B-714008-S	Stop Kit	17.50 set
------------	----------	-----------

B-41484	Bumpers only	7.50 pr
---------	--------------	---------

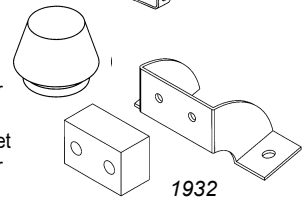

Rumble Hinge and Counterbalance: 1932 3 Window

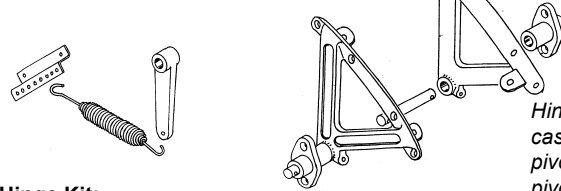

Hinge Kit:

B-713570-S	1932 3 Window, cast steel USA	400.00 set
B-526898-S	Hinge mount reinforcement on body	15.00 pr

Counterbalance:

B-526812	Counterbalance spring bracket	10.00 pr
B-526813	Counterbalance spring	15.00 pr
B-526814	Counterbalance arm, cast aluminum	40.00 ea

Hinge Kits Include cast hinges, cast pivot brackets, and pivot rod.

Bumper and Stops:

B-41518	Upper bumper	7.50 pr
B-526840	Catch striker on lid	not.avbl
B-526844	Catch socket on body	not.avbl



* Parts with price listed as "not.avbl" are not known to be available at this time, but are listed for reference.

1932 Coupes, Sedans, Victoria, Cabriolet Door, Window, Deck Lid, and Interior, cont
Deck Lid Latch for Outside Handle:

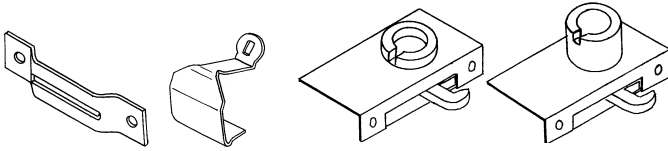

A-41604-A	Latch: 1928-29 Rumble/Trunk, 1928-32 Trunk	100.00 ea
A-41604-B	Latch: 1930-32 Rumble	100.00 ea
A-52500	Striker: 1928-32 Rumble	5.00 ea
B-41615	Striker: 1928-32 Trunk	7.50 ea

Rumble Lid Latch: Remote Style, 3 Window Coupe &

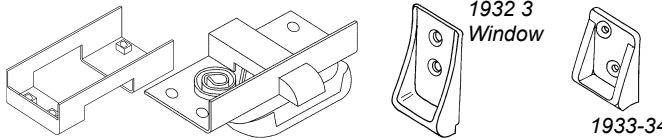

B-527102	Latch	27.50 ea
B-527103	Mount bracket, to drip rail	15.00 ea
40-715600	Handle mount & link, Coupe	27.50 ea
B-525780	Striker, 1932 3 Window, cast iron	10.00 ea
40-765780	Striker, 1933-34, cast stainless	60.00 ea

* Parts with price listed as "not.avbl" are not known to be available at this time, but are listed for reference.