

1932 Roadster and Phaeton Door, Deck lid, and Interior

Outside Door Handle: 1928-33 Roadster & Phaeton

Handles, Die Cast, Chromed
A-702350-O 35.00 ea

Rubber Pads
B-35630 5.00 pr

Mount screws, stainless 3/4" set of 4
B-46212-MS 2.50 set

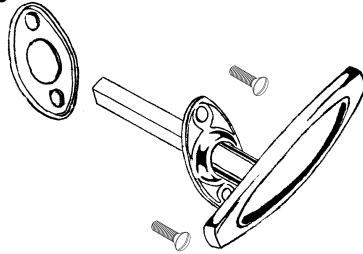

Deck Lid Handle: 1932-34 Rumble or Trunk Lid Handle

Locking, w/keys,
mount outside lid.
Die Cast, chrome

plated. Will fit 1928-37.

40-702352	Handle	50.00	ea
B-41648	Rubber pad	5.00	ea
A-41606-S	Acorn nut only	5.00	ea
A-41606-LW	Lockwasher only	1.00	ea

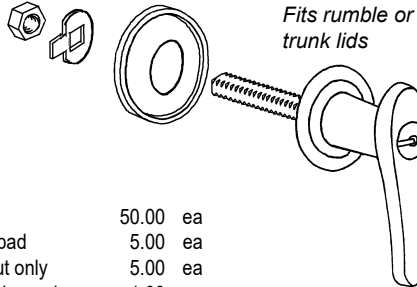

Inside Door Handle 1932 Roadster & Phaeton

18-702400-A	Inside door handles, chrome	60.00	pr
B-48139-BS	Escutcheons, chrome	40.00	pr
A-48140	Dovetail escutcheon THIN upholstery	5.00	ea
18-702400-R	Inside handle to latch links	10.00	pr

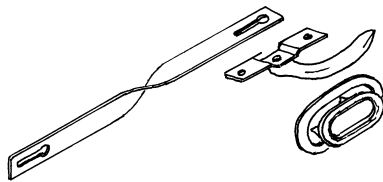

Door Hinges: 1932 Roadster & Phaeton

Investment cast steel. Drilled for pins, Not drilled for mounting.
Original hinges riveted to door

Front or rear body, upper			
B-35600-CU	60.00	ea	
Front or rear door upper			
B-35600-DU	60.00	ea	
Front body lower			
B-35600-CL	60.00	ea	
Front door lower			
B-35600-DL	60.00	ea	
Rear body lower and RPU body:			
B-35600-CUL	60.00	ea	
Rear door lower and RPU door			
B-35600-DUL	60.00	ea	

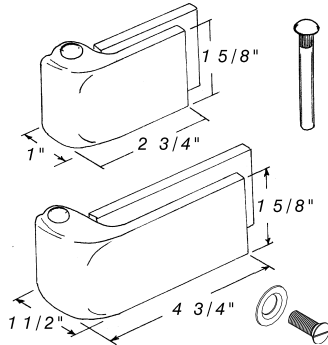

Hinge Pins			
B-35615	Hinge pin, plain	not.avbl	
B-46335-SS	Hinge pin, stainless	5.00	ea
Hinge Screws			
B-35600-M100	Hinge to cowl screw, plain:	2.00	ea
B-35600-M100C	Hinge to cowl screw, chrome:	10.00	ea
B-35600-WW	Hinge to cowl washer, plain:	1.00	ea
B-35600-WWC	Hinge to cowl washer, chrome:	7.50	ea

Hidden Door Hinges: 1932 Roadster & Phaeton

The same hidden hinges used on Wescott fiberglass bodies

Properly installed the door will swing open 90 degrees and nearly level

This is a very difficult installation, requiring modification to door post structure and requires competent body fabrication and body work skills These hinges are NOT RECOMMENDED for any other body style due to different door weight and geometry.

B-35600-HH	1932 Front doors	350.00	ea
B-35600-HHR	1932 Rear doors	350.00	ea

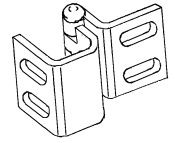

Door Check Straps 1928-32 Roadster & Phaeton

Note: effective with outside hinges only.

A-702828-LS	Leather, with chrome brackets	45.00	pr
-------------	-------------------------------	-------	----

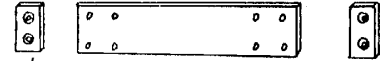

Door Latches and Strikers:

Door Latch:

B-35655	RH front, LH rear	125.00	ea
B-35656	LH front, RH rear	125.00	ea

Door Latch Repair:

B-35655-BSPRING	Bolt spring	5.00	ea
B-35655-HSPRING	Handle spring, RH	5.00	ea
B-35656-HSPRING	Handle spring, LH	5.00	ea

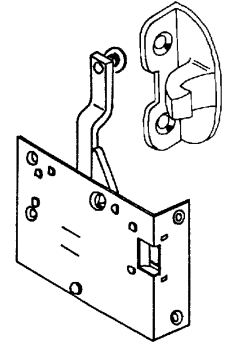

Striker Plates

A-35705	Plain	not.avbl	
A-35705-SS	Stainless	15.00	ea
B-35705-S	Latch striker screws	2.50	set

Door Bumpers and Dovetails

B-46440	Door bumper	1.50	ea
B-35582	Dovetail, stainless	7.50	ea
B-35582-S	mounting screws	not.avbl	
B-35576-AS	Socket, Plain	60.00	pr
B-35576-SS	Socket, Stainless	35.00	pr

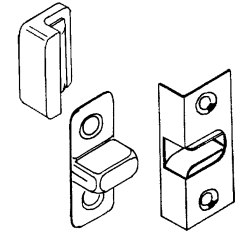

Door Weather Seals: Roadster & Phaeton

Windlacing was used to seal the front and back of doors.
A rubber seal strip mounted inside a retainer strip at bottom of door. Note: Retainer strips are not included with most steel or fiberglass reproduction bodies.

A-79501	1932 Seal (for 2 doors)	12.50	ea
B-35702-RTNR	1932 Retainer (1 per door)	35.00	ea



1932 Door Sill Plates

Stainless Steel

B-46480-CS	Roadster & Phaeton front, trim for rear doors	100.00	pr
------------	---	--------	----

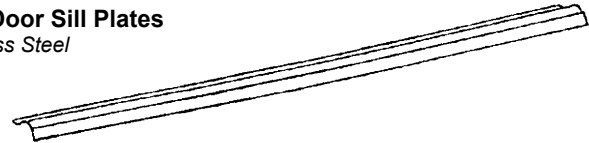

* Parts with price listed as "not.avbl" are not known to be available at this time, but are listed for reference.

1932 Roadster and Phaeton Door, Deck lid, and Interior, cont

Trunk Hinges:

Original style

Pin through upper corner of lid

A-41512-S 27.50 set

Wescott lift style

Uses AH-1114 pivot bolt

B-41513-WT Roadster 100.00 pr

B-41513-W3 Coupe 100.00 pr

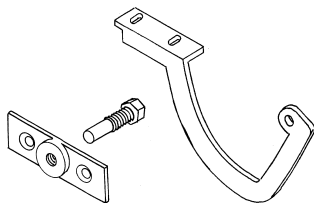

Trunk Prop

A-41530 Prop Arm 27.50 ea

A-41530-MB Shoulder bolt 5.00 ea

Rumble Hinges

Includes cast aluminum hinge arms, mount brackets, and pivot bolts

B-41542-S Roadster 400.00 set

B-47542-S 5 Window not.avbl

B-63572-S Cabriolet not.avbl

AH-1114 Pivot bolt kit 7.50 set

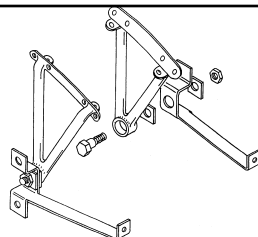

Deck Lid Latch:

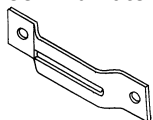

Rumble Striker



Trunk Striker

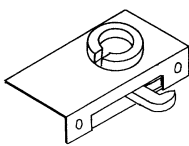

A-41604-A

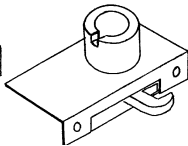

A-41604-B

A-41604-A Latch: 1928-29 Rumble/Trunk, 1928-32 Trunk 100.00 ea

A-41604-B Latch: 1930-32 Rumble 100.00 ea

A-52500 Striker: 1928-32 Rumble 5.00 ea

B-41615 Striker: 1928-32 Trunk 7.50 ea

Deck Lid Bumpers and Stops:

Round (upper rumble/lower trunk) bumpers:

B-41518 7.50 pr



Rumble Stop kit with bumpers

B-714008-S Kit 17.50 set

B-41484 Bumpers only 7.50 pr

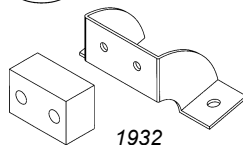

Deck Lid weather seal:

Not used 1926-32. If a seal is desired use the universal style listed above.

* Parts with price listed as "not.avbl" are not known to be available at this time, but are listed for reference.