

1935-47 Pickup and Panel Door, Window, and Interior

Outside Door Handle:

1935-36 Pickup & Panel

Handles, Die cast, Chrome Plated 50-702350	45.00 ea
Rubber Pads B-46212	5.00 pr
Mount screws, stainless 3/4" set of 4 B-46212-MS	2.50 set
Lock Cylinder, w/flipper over keyhole 48-702302	45.00 ea

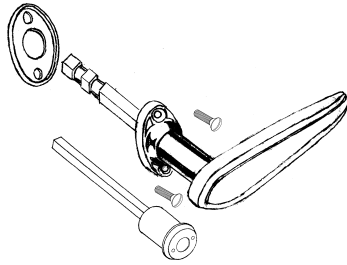

Outside Door Handle:

1937 Pickup,

Handles, Die cast, Chrome Plated 68-702350-B	50.00 ea
Rubber Pads 48-702356	5.00 pr
Mount screws, stainless 3/4" set of 4 B-46212-MS	2.50 set
Lock Cylinder, w/flipper over keyhole 48-702302	45.00 ea

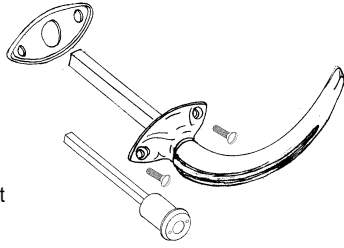

Outside Door Handle:

1938-47 Pickup

Handles, Die cast, Chrome Plated 81A-702350-A	45.00 ea
Rubber Pads 48-702356	5.00 pr
Mount screws, stainless 3/4" set of 4 B-46212-MS	2.50 set
Lock Cylinder, w/flipper over keyhole 48-702302	45.00 ea

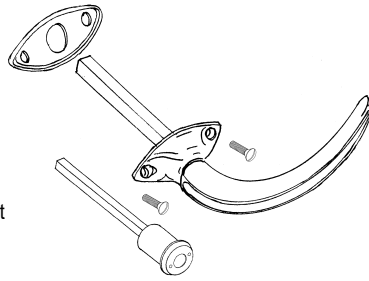

Inside Door Handles

1935-37 Pickup and Panel

40-702400-ES	Inside door handle, chrome	12.50 ea
40-702780-ES	Window riser handle, chrome	12.50 ea
A-46250-P	Handle to shaft pin	0.25 ea
40-48139-C	Escutcheon, stainless	7.50 ea
B-48284	Escutcheon spring (under upholstery)	0.50 ea

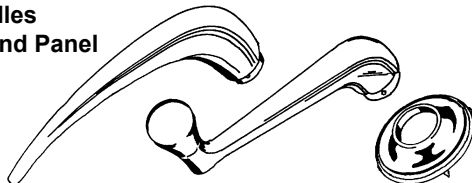

Inside Door Handles

1938-47 Pickup and Panel

81A-702400-S	Inside door handle	20.00 ea
81A-702780-S	Window handle	22.50 ea
A-46250-P	Handle to shaft pin	0.25 ea
91C-48139	Escutcheon	10.00 ea

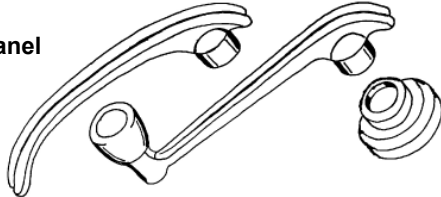

1928-56 Panel Truck Back Door

Inside Handles

A-702400-C	Chrome plated	10.00 ea
------------	---------------	----------



Typical 1935-37 Pickup Window Parts

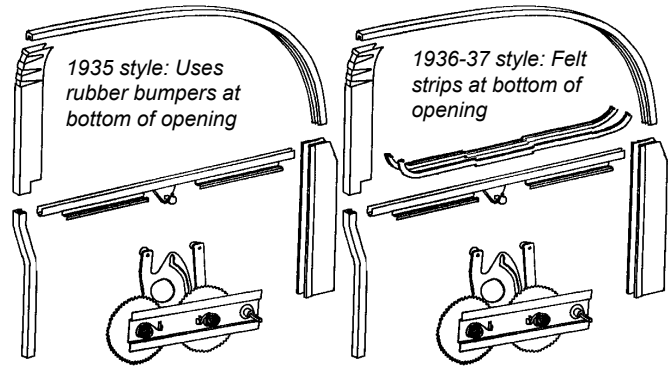

Roll-Up Window Felt Kits

The 1935-early 1936 used felt channel that went around the top and sides of the window and used rubber bumpers at the bottom. The late 1936-1937 used single sided felt at the bottom of the window opening. Each kit does two doors.

50-45983-PUA	1935-36, uses bumpers at window bottom	175.00 ea
50-45983-PUB	1936-37, uses felt all way around window	175.00 ea
81C-45983-PU	1938-39 Pickup & Truck	200.00 ea
01C-45983-PU	1940-41 Pickup & Truck	200.00 ea
21C-45983-PU	1942-47 Pickup & Truck	175.00 ea

Window Regulators

50-812700/1	1935-37 Pickup, Panel	not.avbl
81C-812700/1	1938-47 Pickup, Panel, COE	not.avbl

Door Window Glass Retaining Channels

50-702170	Door, RH: 1935-37 Pickup & Panel	not.avbl
50-702171	Door, LH: 1935-37 Pickup & Panel	not.avbl
81C-702170	Door, RH: 1938-46 Pickup	not.avbl
81C-702171	Door, LH: 1938-46 Pickup	not.avbl

Door Window Glass to Body Seal

Sets glass into channel. Used on 1935-36 style with bumpers at window bottom. When window is rolled up it is sealed to door or body. 6' length.

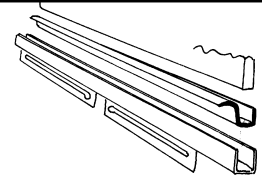

B-45968	10.00 ea
---------	----------

Window Glass to Frame Setting Tape

Used with felt all around window opening. Sets glass into channel.

B-37193-A	all years, 20 ft, 1/32" thick	17.50 ea
B-37193-B	all years, 20 ft, 3/64" thick	17.50 ea
B-37193-C	all years, 20 ft, 1/16" thick	25.00 ea
B-37193-D	all years, 20 ft, 5/64" thick	30.00 ea

1935-39 Sliding Back Window Kit

Excellent reproduction of the rare original accessory

50-813396-K	1935-39 Pickup	250.00 ea
-------------	----------------	-----------

Back Window Seals

10' Length, ends not bonded:

B-704220	15.00 ea
----------	----------

With ends bonded as original:

81C-704220-PD	1938-39 Panel delivery, ends bonded	40.00 pr
01C-704220-PU	1940-47 Pickup, ends bonded	30.00 ea
01C-704220-PD	1940-47 Panel delivery, ends bonded	40.00 pr

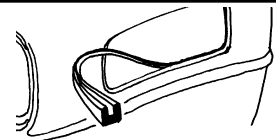

* Parts with price listed as "not.avbl" are not known to be available at this time, but are listed for reference.

1935-47 Pickup and Panel Door, Window, and Interior, cont

1935-47 Pickup Door Hinges

Investment cast steel Hinge pin holes are drilled. Mount holes are not drilled. Cut to length.

Hinge Straps:

(Cowl) hinge straps B-523204-PUC	80.00 ea
(Door) hinge straps B-523204-D	80.00 ea

Hinge Pins

B-46335	Hinge pin, plain	2.50 ea
B-46335-SS	Hinge pin, stainless	5.00 ea
B-46335-XS	Hinge pin, stainless, extra long	5.00 ea

Mounting Screws

B-35600-M100	Hinge to cowl screw, 1935-37, 1" plain	2.00 ea
B-35600-M300	Hinge to body screw, 1935-37 3" plain	5.00 ea
B-35600-WW	Hinge to cowl washer, 1935-37, plain	1.00 ea
78-35600-MS	Hinge to cowl screw, 1938-47 5/16 x 1, set of 3	5.00 set

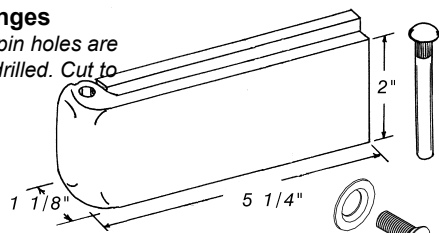

Door Latch and Striker:

Latch Repair

B-46125	Spring: 1935-37	5.00 ea
81A-702267	Spring: 1938-47 small	7.50 ea
81A-702267-A	Spring: 1938-47 large	7.50 ea

Inside Handle Mount

81A-732412/3-NA	Mount w/o link	50.00 pr
B-702268	Inside handle spring	5.00 ea

Striker Plate:

1935-37 Front door

B-46137-A	Striker, Plain	15.00 ea
40-702340-SS	Striker, Stainless	17.50 ea
48-702336-A	Nut plate for striker	17.50 pr

Door Bumpers

1935-37

B-46440	Front door	1.50 ea
B-35184	Rear door	10.00 pr

1938-47

B-46440	Front door	1.50 ea
---------	------------	---------

Door Dovetail

Dovetail:

48-702550-A	1935-42	10.00 ea
11A-702550-A	1944-52	10.00 ea
40-702550-S	Mounting screws	2.00 set

Dovetail Socket Repair Kit:

Note: Housing is welded into door jamb.

48-702574-RK	1935-42 (metal jaw)	15.00 ea
--------------	---------------------	----------

Door Check Arms:

Check arms, 4-1/2" replacement style

48-702828-S	Plain	5.00 pr
81A-702828-SS	Stainless	20.00 ea

Check arm mount brackets to cowl/door

A-702828-BKT	Plain	12.50 pr
--------------	-------	----------

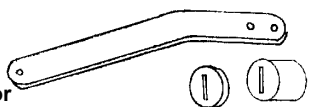

Doors Weather Seals: 1935-37 Pickup

Windlacing is used at the front, back and top of doors. A special retainer strip attaches the windlace and upholstery panels to the body. A rubber seal strip attaches under the upholstery at bottom of door.



40-701980	Lower door seal strip	10.00 ea
-----------	-----------------------	----------

Doors Weather Seals: 1938-52 Pickup

Windlacing was used to seal the front, back and top of doors. A special retainer strip was used to attach the windlace and upholstery panels to the body. A rubber seal strip mounts inside a retainer strip at bottom of door.



B-80230	Lower seal, 1 used per door	10.00 pr
7C-8120712-PR	Lower seal retainer, steel	20.00 pr

Pickup Headliner Kits

Cardboard, pre cut and stitched

01C-8151968-BL	1940-47, black	225.00 ea
----------------	----------------	-----------

* Parts with price listed as "not.avbl" are not known to be available at this time, but are listed for reference.