

## 1941-48 Coupes, Sedans, Cabriolet Door, Window, Deck Lid, and Interior

### Outside Door Handles: 1941-48 Station Wagon

11A-7922428-R Handle Pads, rubber, set of 4 not.avbl

### Outside Door Handles: 1942-48 Passenger

51A-702350 1946-47 Passenger 45.00 ea  
6A-702350 1947-48 Passenger not.avbl  
21A-702302 Lock cylinder, teardrop flipper style 45.00 ea

### Deck Handle: 1941-48 Ford

11A-7043511 Deck handle only, chrome 70.00 ea  
11A-7043512 Deck handle base, chrome 27.50 ea  
99A-13556-SK License light socket/lens/gasket kit 22.50 ea  
11A-13572 Deck Handle Pad, Passenger 5.00 ea  
21A-13572 Deck Handle Pad, 1942 Super Deluxe 27.50 ea  
99A-13564 Deck light lens (included in 99A-13556-SK) 7.50 ea  
11A-13568 Lens gaskets (included in 99A-13556-SK) 5.00 set

### Deck Handle Parts: 1941-48 Mercury

09A-13572 1940 Mercury Deck Handle Pad, rubber 35.00 ea  
19A-13572 1941 Mercury Deck Handle Pad, rubber 15.00 ea  
29A-13572 1942-48 Mercury Deck Handle Pad, rubber 17.50 ea

### 1941-48 Passenger

#### Inside Handles, chrome plated

11A-702400-S Door handle 25.00 ea  
11A-702780-S Window Handle 22.50 ea  
11A-7024448 Crank-out vent handle: Coupe & Sedan not.avbl  
51A-7923410-CC Crank-out vent & quarter window handle: 27.50 ea  
Convertible & Station Wagon  
A-46250-P Handle to shaft pin 0.25 ea

#### Coupe, Sedan & Conv. Door & Window Handle Escutcheons

*With spring loaded metal center.*

B-48139-U 1941-48 Chrome plated 5.00 ea  
11A-48139-T 1941, tan plastic 15.00 ea  
21A-48139-M 1942, maroon plastic 15.00 ea  
21A-48139-B 1942, butterscotch plastic 17.50 ea  
51A-48139-C 1946, chocolate plastic 17.50 ea  
51A-48139-B 1946, blue-gray plastic 17.50 ea  
51A-48139-G 1946-48, gray-tan 17.50 ea

#### 1941-48 Station Wagon Door & Window Escutcheons

11A-7923456-K Set of 8, beaded edges and original shape 17.50 ea

#### Crank-out Vent & Conv. Quarter Handle Escutcheons

81A-48139-C 1941-48 Chrome plated 7.50 ea  
11A-48139-VT 1941, tan 7.50 ea  
21A-48139-VM 1942, maroon 7.50 ea  
21A-48139-VB 1942, butterscotch 7.50 ea  
51A-48139-VC 1946, chocolate 7.50 ea  
51A-48139-VB 1946, blue-gray 7.50 ea  
51A-48139-VG 1946-48, gray-tan 7.50 ea

### Arm Rest Formers

A-56665-PR Front door, 1932-48 Passenger 95.00 pr

### 1941-48 Convertible Door Window Garnish Molding



CG4148CNVR Fiberglass, RH 230.00 ea  
CG4148CNVL Fiberglass, or LH 230.00 ea

### Convertible Window Parts

#### Top of door:

11A-45983-C 1941 Door window felt (at top of door) 95.00 ea  
21A-45983-C 1942-48 Door window felt (at top of door) 95.00 ea

48-762232 1935-48 Glass to window frame setting channel 10.00 ea  
21A-762232 1942-46 Quarter glass to widow frame channel 15.00 pr  
21A-7630106-S 1942-48 quarter window front edge seals 45.00 pr

### Convertible Front Door Vent Window Parts

11A-7621448-S Rubber seals, 1941-48 Convertible 100.00 pr  
11A-7022296-A Rubber seal strip to window frame 1941-48 17.50 pr  
01A-7022916/7 Handle, w/center button, chrome 70.00 pr  
01A-7022938 Handle pivot shaft and bracket 20.00 ea

### Typical 1941-42 & 1946-48 Coupe & Sedan Window Parts 1941-48 Passenger Roll-Up Window Felt Kits

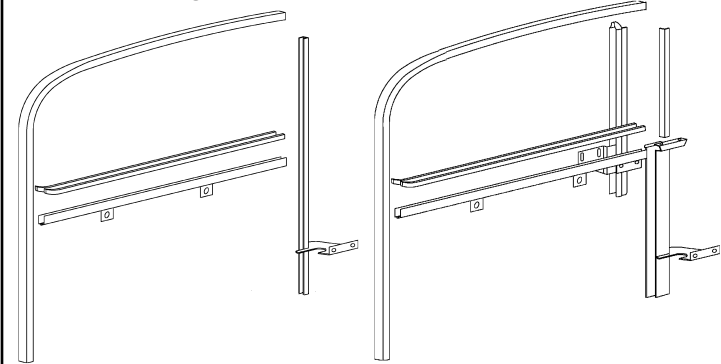

*Kits include all felt channels, window bottom felt, and vent window division felt, installation clips, and screws for 2 windows. Kits do not include felt strip for front vent divider stainless frame strip.*

*1941-42 Type A front inner channel used slotted mounting holes, Type B used threaded mount holes.*

*Business coupe windows are approx 17 1/2" long, Sedan coupe 26"*

11A-45983-2DA 1941-42 Tudor & Sedan Coupe doors (type A) 200.00 ea  
11A-45983-2DB 1941-42 Tudor & Sedan Coupe doors (type B) 200.00 ea  
11A-45983-5WA 1941-42 Business Coupe & Fordor front (A) 200.00 ea  
11A-45983-5WB 1941-42 Business Coupe & Fordor front (B) 200.00 ea  
51A-45983-2D 1946-48 Tudor & Sedan Coupe doors 200.00 ea  
51A-45983-5W 1946-48 Business Coupe & Fordor front doors 200.00 ea  
11A-56786 1941-42 Tudor quarter 200.00 ea  
51A-56786 1946-48 Tudor quarter 165.00 ea  
11A-56791 1941-42 Fordor rear doors 200.00 ea  
51A-56791 1946-48 Fordor rear doors 165.00 ea

### 1941-48 Passenger Window Glass Retaining Channels

*Note: Type A has divider bar brackets opposite regulator arm mount hole brackets. Type B has them on the same side. 1946-48 does not use bracket.*

	RH		LH	
Tudor door A	11A-702170-A	50.00 ea	11A-702171-A	50.00 ea
Tudor door B	11A-702170-B	50.00 ea	11A-702171-B	50.00 ea
Coupe/Fordor Front A	11A-772170-A	50.00 ea	11A-772171-A	40.00 ea
Coupe/Fordor Front B	11A-772170-B	40.00 ea	11A-772171-B	40.00 ea
Fordor rear	11A-56789	50.00 ea	11A-56789	50.00 ea
Tudor Quarter	11A-702170-R	not.avbl	11A-702171-L	50.00 ea

### Window Glass to Frame Setting Tape

B-37193-A All years, 20 ft, 1/32" thick 17.50 ea  
B-37193-B All years, 20 ft, 3/64" thick 17.50 ea  
B-37193-C All years, 20 ft, 1/16" thick 25.00 ea  
B-37193-D All years, 20 ft, 5/64" thick 30.00 ea

\* Parts with price listed as "not.avbl" are not known to be available at this time, but are listed for reference.

## 1941-48 Coupes, Sedans, Cabriolet Door, Window, Deck Lid, and Interior, cont

### Coupe and Sedan Front Door Vent Window Parts

11A-7021448-S	Rubber seals, 1941-48 Coupe & Sedan	80.00 pr
11A-7022296	Vent window to door window seal, 1941-42, fuzz	25.00 pr
51A-7022296	Vent window to door window seal, 1946-48, rubber	25.00 pr
01A-7022916/7	Handles, w/center button, chrome	70.00 pr

### Coupe & Fordor Sedan Popout Quarter Window Parts

11A-773540-S	Rubber seal, 1941-46 w/full surround ring	140.00 pr
51A-7229904/5-A	Rubber seal, 1946-48 w/part surround ring	130.00 pr
78-735280	Window handle, chrome, RH	22.50 ea
78-735281	Window handle, chrome, LH	22.50 ea
01A-7022938	Window handle pivot shaft & bkt	20.00 ea

### Back Window Seals, ends seamed as original.

11A-704220	1941-48 Ford Pass (no groove)	35.00 ea
19A-704220	1941-48 Mercury (w/chrome groove)	30.00 ea
11A-7941936-K	1941-48 Station Wagon	95.00 pr
21A-704220-SD	1942-48 Sedan delivery	40.00 ea

### Lower Door Hinges: 1941-48 Passenger

Lower hinge straps are investment cast steel. Hinge pin holes are drilled. Mount holes are not drilled. Cut to length.

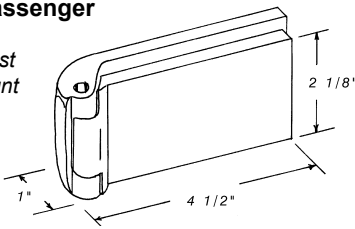

#### Lower Hinge:

78-702454-C	Body side	75.00 ea
78-702454-D	Door side	75.00 ea

#### Hinge Pins (for lower hinges only)

B-46335	Plain	2.50 ea
B-46335-SS	Stainless	5.00 ea
B-46335-XS	Stainless, Xlong	5.00 ea

### Door Check Arms:

#### Check arms, 4-1/2" replacement style

48-702828-S	Plain	5.00 pr
81A-702828-SS	Stainless	20.00 ea



#### Check arm mount brackets to cowl/door

A-702828-BKT	Plain	12.50 pr
--------------	-------	----------

### Door Latches: 1941-48 Coupe, Sedan, Convertible

#### Latch Repair:

11A-702267	Spring, large	7.50 ea
11A-702267-A	Spring, small	7.50 ea
11A-702268	Inside handle spring	5.00 ea

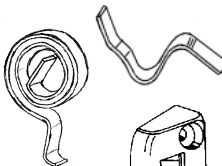

#### Striker:

11A-7022008	Latch striker, plain	25.00 ea
11A-7022008-C	Latch striker, chrome	12.50 ea
11A-7022026	Latch striker pad	5.00 pr

### Door Bumpers

#### Door Jamb Bumper

78-46440	1.50 ea
----------	---------

#### Upper Rear Corner Bumper

11A-7023020-B	3.00 pr
---------------	---------

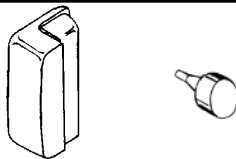

### Door Dovetails:

#### Dovetail:

11A-702550-A	Dovetail, stainless	15.00 ea
40-702550-S	Mounting screws	2.00 set

#### Dovetail Socket:

Note: Dovetail socket housing is welded into door jamb.

11A-702574-RK	Repair kit	7.50 ea
11A-702570-S	Socket assy, weld in	20.00 pr

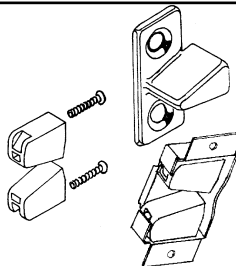

### Door Seals: 1941-48 Passenger

Sponge rubber seals were glued to the door to seal to the door jamb both front and rear. Coupes and sedans use a rubber seal that glues to the top of the door. The lower seal was mounts on top of the sill plate.

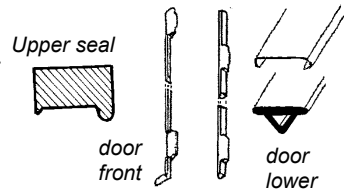

78-7043724-AS	Upper seal kit, for two doors	10.00 pr
11A-701884-S	Front jamb seals; Coupe & Sedan	25.00 pr
11A-711884-S	Front jamb seals; Convertible	30.00 pr
11A-7020546	Back door seal, upper, Coupe & Tudor	7.50 set
11A-7620546	Back door seal, upper, Convertible	12.50 set
11A-7320546	Back door seal, upper, Fordor sedan	20.00 set
11A-7020535	Back door seal, lower edge	15.00 pr
11A-701980	Lower door seal strip, use 1 per door	7.50 ea
11A-7013224/25	Lower seal retainer, Tudor, Conv, 5pCoupe	95.00 pr
11A-7313224/25	Lower seal retainer, Coupe, 4d front	85.00 pr
11A-7323252/53	Lower seal retainer, 4d rear	85.00 pr

### Door & Tailgate Seals: 1941-48 Station Wagon

21A-791980	Door seals: Complete kit	not.avbl
11A-7952086-K	Tailgate seals: Complete kit	not.avbl

### 1941-48 Door Sill Plates

11A-7013250-S	Tudor sedan, Sedan coupe, & Convertible	100.00 pr
11A-7713250-S	Business coupe, Sedan delivery & Fordor sedan front doors	95.00 pr
11A-7313262-S	Fordor rear doors	85.00 pr

### Trunk Lid Hinges and Latch:

#### 1941-48

21A-7642700-SS	Hinges: 1941-48 Coupe & Convertible	125.00 ea
11A-7744200-S	Props: 1941-48 Coupe & Convertible	250.00 pr
99A-7044200-S	Props: 1939-48 Sedans	250.00 pr
91A-41513-MB	Prop shoulder bolt (to body)	20.00 ea
21A-52502-A	Latch (rotater type): 1941-48 Coupe*	not.avbl
11A-52502-B	Latch (plunger type): 1941-48 Sedan*	32.50 ea
11A-52500	Striker: 1941-48 Coupe*	50.00 ea
11A-52500-B	Striker: 1941-48 Sedan*	50.00 ea
*some early 1941 coupes used plunger type latch		
11A-41518	Trunk lid rubber bumpers	5.00 pr

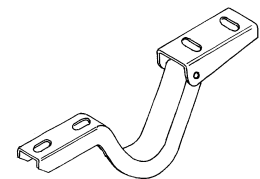

### Deck Lid Seals: 1941-48

Sponge Rubber (as original, no corners):

78-713450	Coupe, Sedan, Convertible w/trunk	25.00 ea
51A-713450	Sportsman Convertible	30.00 ea

Hollow core sponge rubber with bonded corners:

11A-713540	Coupe & Convertible	55.00 ea
21A-7043720	Sedans	55.00 ea

\* Parts with price listed as "not.avbl" are not known to be available at this time, but are listed for reference.