

1933-34 Commercial Grille, Hood, Fenders and Running Boards

Unless noted, fits 112" wb Pickup and Panel, and Big Trucks

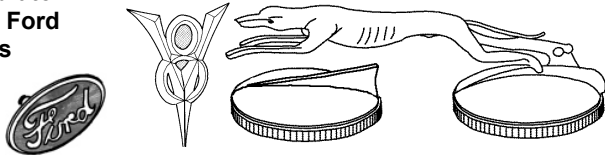

1933 Radiator Cap and Ford Emblems



B-8212	Ford Emblem, chrome w/blue background	25.00 ea
40-8217-A	V8 Emblem, chrome	50.00 ea
46-8100-A	Radiator Cap (includes internal guts), chrome	55.00 ea
B-8100-G	Greyhound Radiator Cap, (1932, works on PU) internal guts not included.	not.avbl
B-8100-K	Radiator cap internal guts	10.00 set

1934 Grille Ornament & Radiator Cap

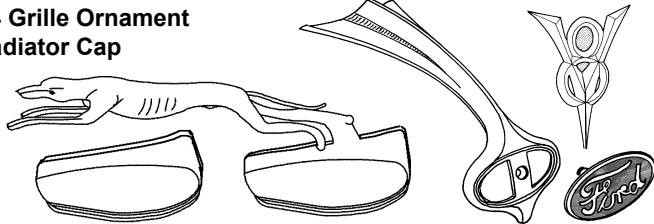

46-8215	Grille ornament	65.00 ea
B-8212	Ford emblem	25.00 ea
40-8217-A	V8 Emblem, chrome	50.00 ea
46-8100	Radiator Cap (stock), includes internal guts	55.00 ea
46-8100-AG	Greyhound Radiator Cap, guts not included	not.avbl
B-8100-K	Radiator cap internal guts	10.00 set

Grille

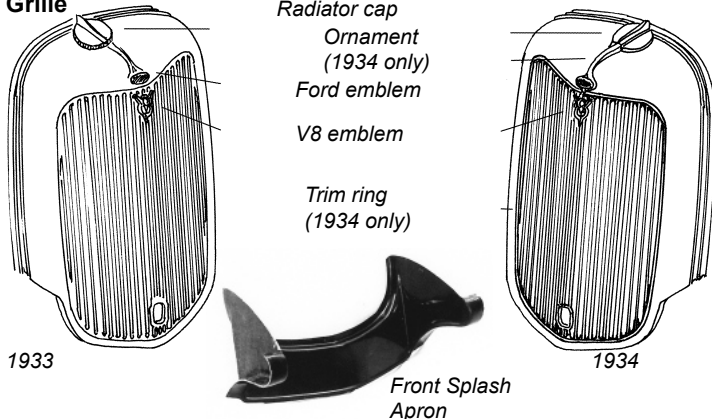

46-8200-A	1933 Grille	not.avbl
46-8200-B	1934 Grille	not.avbl
46-8234	1934 Trim ring	160.00 ea
68-20004	Grille trim clip set	20.00 set
46-8094-BS	Grille to radiator spacers and bolts	45.00 ea
A-8201-BM	Grille to spacer bracket bolts only	2.50 set
FSA3334PU	Front Splash Apron, Fiberglass	200.00 ea

Stock and Street Rod Hoods

Steel hoods by Rootlieb.

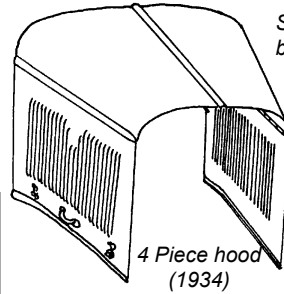

4 Piece hood (1934)

Hood top includes passenger type center hinge. (Stock hinge not available on top panels) Side panels are complete with hood handles and hinge rods.

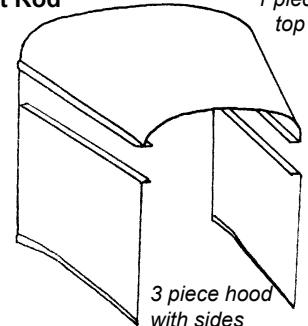

3 piece hood with sides

Hood top can be used as a top panel only. Side panels do not have handles. Hood hinges and top panel braces not included, sold separately.

Hood Tops

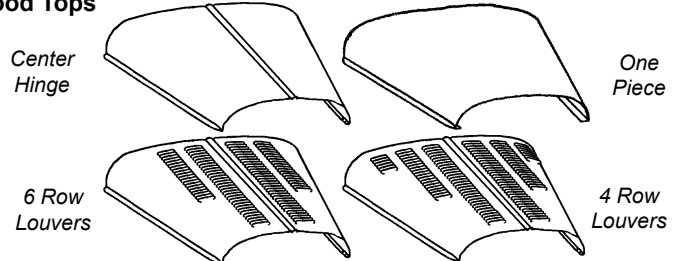

Center Hinge	One Piece
6 Row Louvers	4 Row Louvers
4 Piece	3 Piece (1 pc top)
Top, Plain 46-16710-2	350.00 ea
Top, Louvered, (4 rows) 46-16710-2L6	500.00 ea
46-16710-3	350.00 ea
46-16710-3L4	475.00 ea

Hood Sides

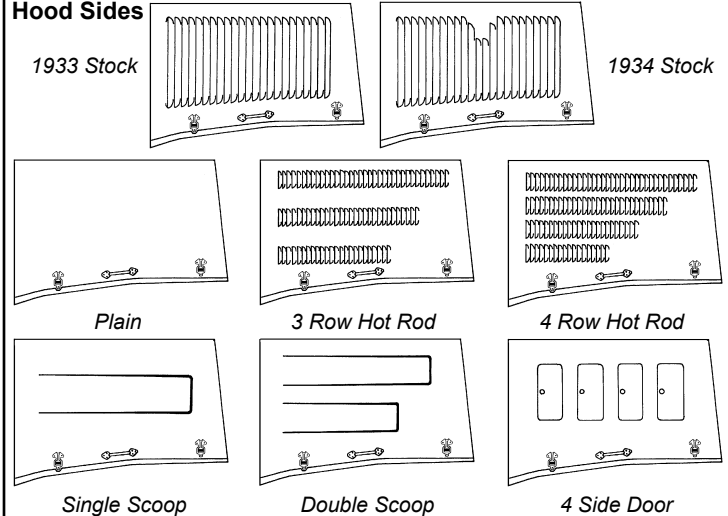

4 Piece	3 Piece (1 pc top)
Sides, 1933 Stock style 46-16712-A	350.00 pr
Sides, 1934 Stock style 46-16712-B	350.00 pr
Sides, Hot rod (3 row) 46-16712-H	350.00 pr
Sides, Hot rod (4 row) 46-16712-H4	350.00 pr
Sides, Plain 46-16712-P	350.00 pr
Sides, 4 door 46-16712-D	850.00 pr
Sides, Single scoop 46-16712-S1	675.00 pr
Sides, Double scoop 46-16712-S2	1000.00 pr
46-16713-A	270.00 pr
46-16713-B	270.00 pr
46-16713-H	270.00 pr
46-16713-P	270.00 pr
46-16713-S1	600.00 pr
46-16713-S2	925.00 pr

* Parts with price listed as "not.avbl" are not known to be available at this time, but are listed for reference.

1933-34 Commercial Grille, Hood, Fenders and Running Boards, cont

1934 Pickup Hood Side Emblems

46-16606	"Ford"	145.00 pr
46-16607	"V8"	not.avbl



Hood Hinge Brackets

Original type: Stainless, use with original interlocking center hood hinge.

46-8220	Front	25.00 ea
46-8221	Rear	22.50 ea

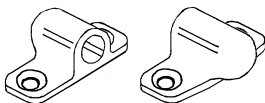

Hood V8 Center Hinge Brackets

Use with Rootlieb Hood w/V8 hinge

Front or Rear:

Chrome plated

B-8220	25.00 ea
--------	----------

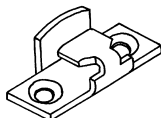

1928-36 Accessory Hood Supports, Stainless Steel

HR-16780-SS	Mount to radiator support rods	45.00 ea
-------------	--------------------------------	----------

Hood Latches (original type)

Hood Latches

B-16750	Plain	12.50 ea
B-16750-SS	Stainless	20.00 ea

Hood Latch Mount Screw Set

B-16750-MS	Stainless Steel	7.50 set
------------	-----------------	----------

Hood Latch to Fender Pads, Rubber

B-16750-PAD	oblong type	17.50 ea
B-35630	oval type	5.00 pr

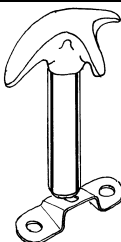

Hood Side Hardware and Bumpers

A-16636	Hood side handles, Plain, w/rivets	25.00 pr
A-16636-SS	Hood side handles, Stainless, w/screws	35.00 pr
B-16751-S	Hood latch catch brackets, set of 4 w/rubbers	30.00 set
B-16751-SS	Hood latch catch set, stainless	40.00 set
A-16751-RS	Dummy (threaded) rivets, chrome, set of 20	10.00 set
B-16761	Hood bumper set	27.50 set
B-16718-S	Center bumper bracket (mounts to fender)	not.avbl

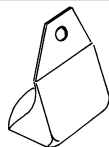

Hinge and Braces for 3-Piece Hoods

Top Panel Braces

3/8" round steel braces provide extra support. This minimizes flexing and helps to avoid cracking paint and smooths operation of hidden hinges.

46-16714-DF	Braces	not.avbl
-------------	--------	----------

Hidden hinge and latch kit:

By DF Metalworks. Includes hinges, latches, and side panel lower alignment pins. Hardware and instructions are included.

B-16711-DF	LH Open	not.avbl
B-16711-DF2	2 Way Open	not.avbl

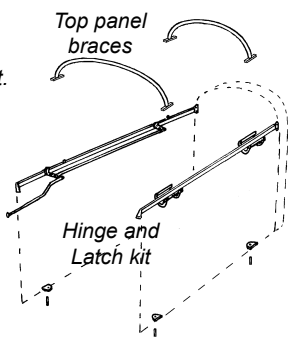

Hood Lacing

50-16739-S	Grille, fabric w/rivets	17.50 ea
48-16740-S	Cowl, fabric w/screws	25.00 ea
HR-16739	Foam rubber, 3/8" x 3/16" (most rad shells)	15.00 ea
HR-16740	Foam rubber, 5/8" x 3/8" (most cowls)	25.00 ea

Fenders, Fiberglass

Front fenders fit 1933-34 Pickup, Panel, and Trucks.



RFF3334PU	RH Front, plain	500.00 ea
LFF3334PU	LH Front, plain	500.00 ea
RFF3334PU6	RH Front w/6" spare tire well	625.00 ea
LFF3334PU6	LH Front w/6" spare tire well	625.00 ea
RFF3334PU8	RH Front w/8" spare tire well	625.00 ea
LFF3334PU8	LH Front w/8" spare tire well	625.00 ea
RRF3334PU	RH Rear: Pickup & Panel	375.00 ea
LRF3334PU	LH Rear: Pickup & Panel	375.00 ea

Pickup rear fenders can be converted to 112 wb (1/2 ton) Panel rear fenders by trimming inside mounting flanges to match the panel body.

Front Fender Bracket and Bolts

Fender Bracket

46-16025-R	RH	not.avbl
46-16025-L	LH	not.avbl

Front fender to fender bracket:

B-16026-S2	1/2" long	5.00 pr
------------	-----------	---------

Front fender to frame (slotted)

A-16027-SS	Set of 4	5.00 set
------------	----------	----------

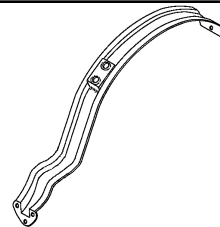

Rear Wheelwell Studs

Large head fender mount bolt, spot welds to wheelwell of pickup box.

AH-1173	Set of 4	1.00 ea
---------	----------	---------

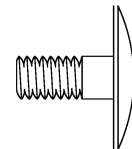

Fender Welt

Black vinyl, 25 ft. length

48-16070-B	3/16" bead	17.50 ea
48-16070-D	1/4" bead	17.50 ea

Vinyl, clad w/stainless bead, 8 ft. length

48-16070-SS	7/32" bead	30.00 ea
-------------	------------	----------

Vinyl, COLORED, Use part suffix to indicate color

Maroon: -MR, Caramel: -CR, Medium Blue: -BLM, Red: -RD, Dark Brown: -BRD, Dark Green: -GRD, White: -WH, Grey: -GY, Bright Orange: -OR, Yellow: -YL, Bright Red: -RR

48-16070-xx	25 ft length, Specify Color	40.00 ea
-------------	-----------------------------	----------

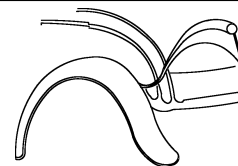

Running Boards, fit 1/2 ton only

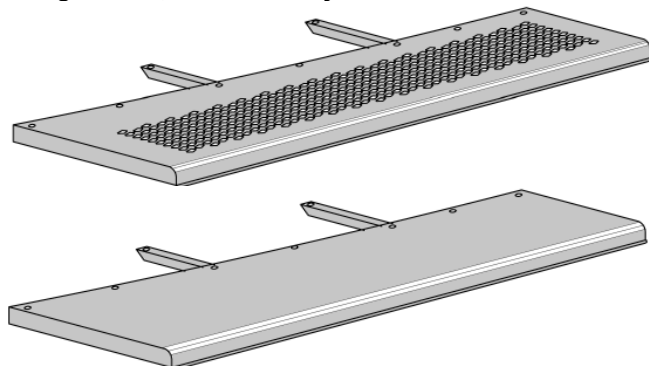

46-16450-S	Stamped steel, w/stock diamond tread	550.00 pr
46-16450-SM	Stamped steel, smooth	400.00 pr

* Parts with price listed as "not.avbl" are not known to be available at this time, but are listed for reference.