

1938 Standard & Deluxe, 1939 Standard Grille, Hood, Fenders and Running Boards

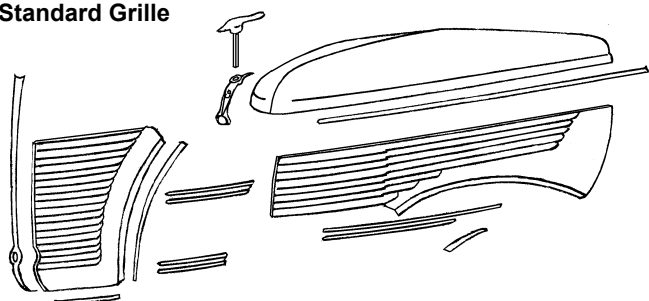

1938 Standard Grille, Hood and Front Fenders

1938 Standard Grille



81A-8200-A	Grille (rh and lh panels)	not.avbl
81A-8209	Grille center vertical brace	not.avbl
81A-8232-A	Grille rear horizontal tie bar	not.avbl

1938 Standard Radiator Shroud

81A-8084/5-A	Radiator side panels	not.avbl
81A-8240-A	Grille inner baffel	not.avbl
81A-16550	Grille to crossmember shield	not.avbl

1938 Standard Hood Handles & Ornaments

81A-8215-A	Hood handle	not.avbl
81A-8218-A	Hood handle base	not.avbl
81A-8227-A	Hood handle base gasket	2.00 ea
48-8212	Hood ornament "Ford" emblem, chrome/blue	20.00 ea
81A-8259-A	Hood ornament "85" emblem, chrome/blue	50.00 ea

1938 Standard Hood Latch

81A-16627-A	Hood latch dowel	not.avbl
81A-16628	Hood latch cam	not.avbl
81A-16650	Hood handle tension spring	not.avbl

1938 Standard Hood

81A-16710-A	Hood top	not.avbl
81A-16618-A	Hood side panel RH	not.avbl
81A-16619-A	Hood side panel LH	not.avbl
81A-16750-RK	Hood side panel mounting studs & brackets	50.00 ea

1938 Standard Hood and Grille Trim

81A-8157-A	Grille trim, center, stainless	not.avbl
81A-8184/5-A	Grille trim, sides, stainless	not.avbl
81A-8330-S	Grille horizontal trim (12 pcs), stainless	not.avbl
81A-16722-AS	Hood side trim, lower	not.avbl
81A-16723-AS	Hood side trim, grille bar	not.avbl
81A-20001-A	Trim clips: grille bar and hood louver (56 pcs)	15.00 set
81A-20004-A	Trim clips: grille and hood side (12 pcs)	10.00 set

1938 Standard Hood Hinges & Props

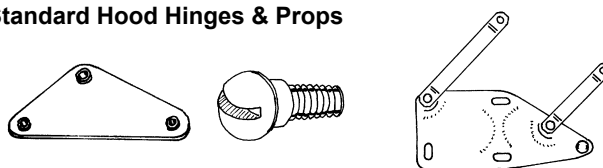

91A-16796/7	Hinges, plain	70.00 pr
91A-16796/7-SS	Hinges, Stainless	85.00 pr
91A-16796-HK	Hinge bolts w/safety wire, set of 4	7.50 ea
78-16746/7	Pads, rubber	10.00 pr
78-16782	Props (ratchet type)	not.avbl
01A-16782-MS	Prop sholder screws, plain	10.00 pr
01A-16782-MSS	Prop sholder screws, stainless	12.50 pr

1938 Standard Hood Lacing and Hood Rubber Bumpers

78-16740-S	Hood lacing, rubber, w/screws,	10.00 ea
78-16761	Hood rubber bumper set	27.50 set

1938 Standard Front Fenders, Fiberglass



RFF38SP	RH front, 1938 Standard Passenger	725.00 ea
LFF38SP	LH front, 1938 Standard Passenger	725.00 ea
RFI38SP	RH inner fender, 1938 Standard	250.00 ea
RFI38SP	LH inner fender, 1938 Standard	250.00 ea

Front Fender Brackets

Fender to Frame:			
48-16067-R	RH	30.00 ea	
48-16067-L	LH	30.00 ea	
Fender skirt (behind tire)			
78-16094	RH or LH	50.00 ea	

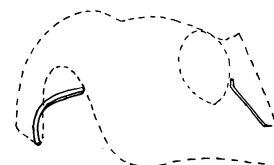

* Parts with price listed as "not.avbl" are not known to be available at this time, but are listed for reference.

**1938 Standard & Deluxe, 1939 Standard
Grille, Hood, Fenders and Running Boards, cont**

**1938 Deluxe
Grille, Hood and Front Fenders**



1938 Deluxe Grille

illustration in progress

81A-8200-B	Grille (rh and lh panels)	not.avbl
81A-8157-B	Grille center vertical ornament	475.00 ea
81A-16626	Grille upper horizontal tie/latch catch	not.avbl

1938 Deluxe Radiator Shroud

81A-8084/5-B	Radiator side panels	not.avbl
81A-8240-B	Grille inner baffel	not.avbl
81A-16550	Grille to crossmember shield	not.avbl

1938 Deluxe Hood Handles & Ornaments

81A-8215-B	Hood handle	not.avbl
81A-8218-B	Hood handle base	not.avbl
81A-8227-B	Hood handle base gasket	2.00 ea
81A-16852	Hood nose ornament	225.00 ea
48-8212	Hood ornament "Ford" emblem, chrome/blue	20.00 ea
81A-16605/6	Hood side V8 emblems	27.50 pr

1938 Deluxe Hood Latch

81A-16628	Hood latch cam	not.avbl
81A-16650	Hood handle tension spring	not.avbl

1938 Deluxe Hood

81A-16710-B	Hood top	not.avbl
81A-16618-B	Hood side panel RH	not.avbl
81A-16619-B	Hood side panel LH	not.avbl
81A-16750-RK	Hood side panel mounting studs & brackets	50.00 ea

1938 Deluxe Hood and Grille Trim

81A-8184/5-B	Grille trim, sides, stainless	not.avbl
81A-16722-BS	Hood side trim, lower	not.avbl
81A-20004-B	Trim clips: grille and hood side (10 pcs)	10.00 set

1938 Deluxe Hood Hinges & Props

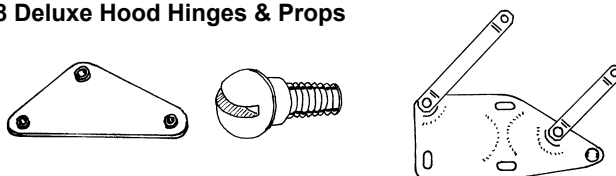

91A-16796/7	Hinges, plain	70.00 pr
91A-16796/7-SS	Hinges, Stainless	85.00 pr
91A-16796-HK	Hinge bolts	7.50 ea
	w/safety wire, set of 4	
78-16746/7	Pads, rubber	10.00 pr
78-16782	Props (ratchet type)	not.avbl
01A-16782-MS	Prop sholder screws, plain	10.00 pr
01A-16782-MSS	Prop sholder screws, stainless	12.50 pr

1938 Deluxe Hood Lacing and Hood Rubber Bumpers

78-16740-S	Hood lacing, rubber, w/screws,	10.00 ea
78-16761	Hood rubber bumper set	27.50 set

1938 Deluxe Front Fenders, Fiberglass



RFF3839P	RH front, 1938 Dix, 1939 Std	725.00 ea
LFF3839P	LH front, 1938 Dix, 1939 Std	725.00 ea
RFI3839P	RH inner fender, 1938 Dix, 39 Std	250.00 ea
LF13839P	LH inner fender, 1938 Dix, 39 Std	250.00 ea

Front Fender Brackets

Fender to Frame:		
48-16067-R	RH	30.00 ea
48-16067-L	LH	30.00 ea
Fender skirt (behind tire)		
78-16094	RH or LH	50.00 ea

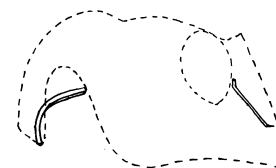

* Parts with price listed as "not.avbl" are not known to be available at this time, but are listed for reference.

**1938 Standard & Deluxe, 1939 Standard
Grille, Hood, Fenders and Running Boards, cont**



1939 Standard Grille

illustration in progress

91A-8200-A	Grille (rh and lh panels)	not.avbl
91A-8157-A	Grille center vertical ornament	475.00 ea
81A-16626	Grille upper horizontal tie/latch catch	not.avbl

1939 Standard Radiator Shroud

81A-8084/5-B	Radiator side panels	not.avbl
91A-8240-B	Grille inner baffel	120.00 ea
81A-16550	Grille to crossmember shield	not.avbl

1939 Standard Hood Handles & Ornaments

91A-8215-A	Hood handle	not.avbl
91A-8218-A	Hood handle base	425.00 ea
91A-8227-A	Hood handle base gasket	not.avbl
91A-8259	Hood nose "85" emblem	not.avbl
91A-16606	Hood side "Ford" emblems	32.50 ea

1939 Standard Hood Latch

81A-16628	Hood latch cam	not.avbl
81A-16650	Hood handle tension spring	not.avbl

1939 Standard Hood

81A-16710-B	Hood top	not.avbl
91A-16618-A	Hood side panel RH	not.avbl
91A-16619-A	Hood side panel LH	not.avbl
81A-16750-RK	Hood side panel mounting studs & brackets	50.00 ea

1939 Standard Hood and Grille Trim

91A-8330-S	Grille horizontal trim (6 pcs), stainless	not.avbl
91A-16724-AS	Hood side trim	not.avbl
91A-16722-AS	Hood louver trim (4pc)	not.avbl
91A-20001-A	Trim clips: grille and hood side (30 pcs)	10.00 set

1939 Standard Hood Hinges

Hood Hinges:

91A-16796/7	Plain	70.00 pr
91A-16796/7-SS	Stainless	85.00 pr

Hood Hinge to Cowl Pads

78-16746/7	Rubber	10.00 pr
------------	--------	----------

Hood Hinge Bolts

includes safety wire

91A-16796-HK	Set of 4	7.50 ea
--------------	----------	---------

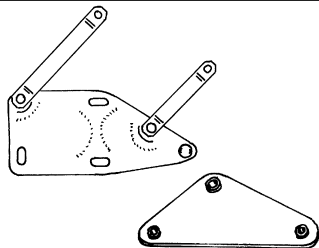

1939 Standard Hood Props

Hood Support Arms with Springs

Uses shoulder bolt top and bottom

91A-16782/3	Plain	100.00 pr
91A-16782/3-SS	Stainless	95.00 pr

1939-48 Spring only (replacement):

91A-16789	Plain	10.00 ea
91A-16789-SS	Stainless	15.00 ea

Hood Support Shoulder Screws

01A-16782-MS	Plain	7.50 pr
01A-16782-MSS	Stainless	12.50 pr

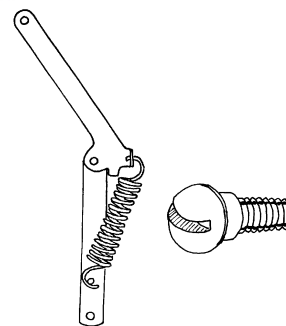

1939 Standard Hood Lacing and Hood Rubber Bumpers

78-16740-S	Hood lacing, rubber, w/screws,	10.00 ea
78-16761	Hood rubber bumper set	27.50 set

1939 Standard Passenger Front Fenders, Fiberglass



RFF3839P	RH front, 1938 Dlx, 1939 Std	725.00 ea
LFF3839P	LH front, 1938 Dlx, 1939 Std	725.00 ea
RFI3839P	RH inner fender, 1938 Dlx, 39 Std	250.00 ea
LF13839P	LH inner fender, 1938 Dlx, 39 Std	250.00 ea

Front Fender Brackets

Fender to Frame:

48-16067-R	RH	30.00 ea
48-16067-L	LH	30.00 ea

Fender skirt (behind tire)

78-16094	RH or LH	50.00 ea
----------	----------	----------

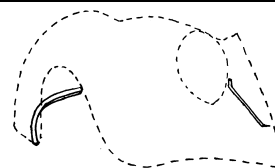

* Parts with price listed as "not.avbl" are not known to be available at this time, but are listed for reference.

**1938 Standard & Deluxe, 1939 Standard
Grille, Hood, Fenders and Running Boards, cont**

**Rear Fenders:
1938**

Coupe & Convertible

Fiberglass

Right:
RRF38C 550.00 ea

Left:
LRF38C 550.00 ea



Rear Fenders:

**1938 Phaeton,
Standard Sedan,
Convertible Sedan**

Fiberglass

Right:
RRF38S 550.00 ea

Left:
LRF38S 550.00 ea



Rear Fenders: 1938 Deluxe Sedan, 1939 Coupe & Sedan



Fiberglass

RRF3840P	RH: No taillight mount	550.00 ea
LRF3840P	LH: No taillight mount	550.00 ea
RRF3839P	RH: 1939 taillight mount	550.00 ea
LRF3839P	LH: 1939 taillight mount	550.00 ea
RRF40P	RH: 1940 taillight mount	550.00 ea
LRF40P	LH: 1940 taillight mount	550.00 ea

**Sedan Delivery
Rear Fenders**

Fiberglass

Right:
RRF3539SD 550.00 ea

Left:
LRF3539SD 550.00 ea



Teardrop Fender Skirts, Fiberglass

Excellent fiberglass reproductions of the aftermarket bubbled fender skirts that were so popular in the '50's. Includes locking arms to latch to the top of the fender, clamps to the bottom of the skirts to the front and rear of the wheel opening, stainless screws, and rubber seals.

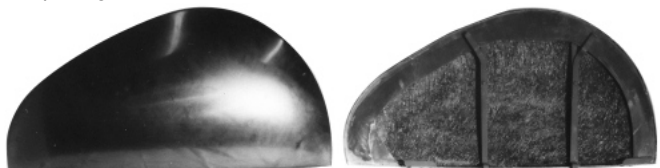

FST3740F Fender Skirts, fiberglass 800.00 pr

Rear Fender Braces

Fits RH or LH

78-16391 30.00 ea

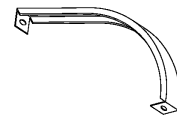

5/16-24 Cage Nuts

Welded to body and frame for fender and running board mounting.

AH-3145 Cage nut 5.00 ea

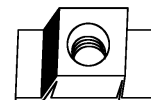

Fender Welt

Black vinyl, 25 ft. length

48-16070-B 3/16" bead 17.50 ea

48-16070-D 1/4" bead 17.50 ea

Vinyl, clad w/stainless bead, 8 ft.

48-16070-SS 7/32" bead 30.00 ea

Vinyl, COLORED, Use part suffix to indicate color

Maroon: -MR, Caramel: -CR, Medium Blue: -BLM, Red: -RD, Dark Brown: -BRD, Dark Green: -GRD, White: -WH, Grey: -GY, Bright Orange: -OR, Yellow: -YL, Bright Red: -RR

48-16070-xx 25 ft length, Specify Color 40.00 ea

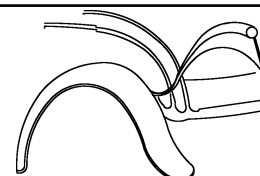

Running Boards

Fiberglass boards are very strong, over 1/4" thick and have the proper arch for excellent fit and appearance.

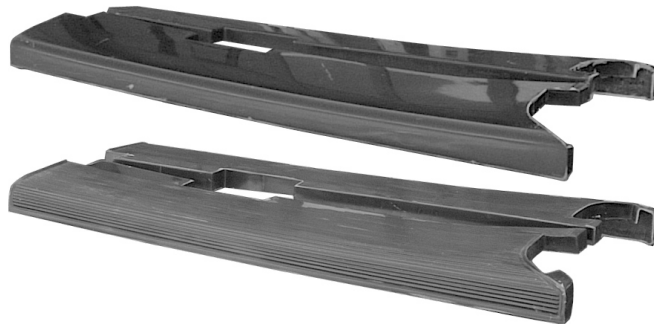

Fiberglass, smoothie style:

RRB3739PS	RH, smooth running board	500.00 ea
LRB3739PS	LH, smooth running board	500.00 ea

Fiberglass, w/molded ribs to simulate original style:

RRB3739P	RH, w/molded ribs	500.00 ea
LRB3739P	LH, w/molded ribs	500.00 ea

Steel boards and rubber covers:

Steel boards with vulcanized rubber covers are excellent quality

78-16450/1-BD	Running boards w/molded covers	1400.00 pr
78-16450/1	Molded rubber replacement covers	300.00 pr
48-16455-MB	1935-48 Running board mount bolt	1.00 ea
78-16453-S	Running board mount bolt set, 37-48	12.50 set

1937-39 Running Board Stainless Moldings

78-16462-S	1937-38 Passenger, 1939 Standard	110.00 pr
------------	----------------------------------	-----------

