

**1939 Deluxe, 1940 Standard and Deluxe
Grille, Hood, Fenders and Running Boards**

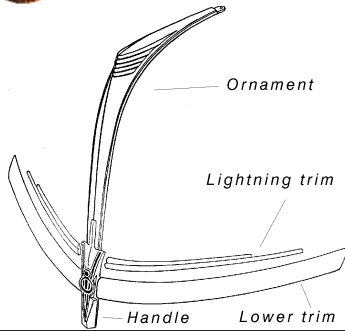

**1939 Deluxe
Hood Handle & Ornament**

Hood Ornament, chrome	
91A-8218-C	375.00 ea
Hood ornament mount spacers	
91A-8219-S	set (3) 25.00 set
Hood Handle	
91A-8215-C	Handle 100.00 ea
91A-2466	mount pin 5.00 ea
Hood front trim, chrome	
91A-8264-S	Lower 250.00 pr
91A-8266-BS	"Lightning" 150.00 pr



1939 Deluxe Front Emblems

91A-16606	"Ford"	32.50 ea
91A-16607	"Deluxe"	32.50 ea



Hood Stainless Trim

91A-16736	Center trim strip, stainless, 1939 Deluxe	70.00 ea
91A-20003	Center trim mount clips	5.00 set
91A-16722-B	Side trim strip, upper, RH, stainless, 1939 Deluxe	not.avbl
91A-16723-B	Side trim strip, upper, LH, stainless, 1939 Deluxe	not.avbl
91A-16724-B	Side trim strip, lower, RH or LH, stainless 1939 Dlx	not.avbl

**1939 Deluxe
Grille**

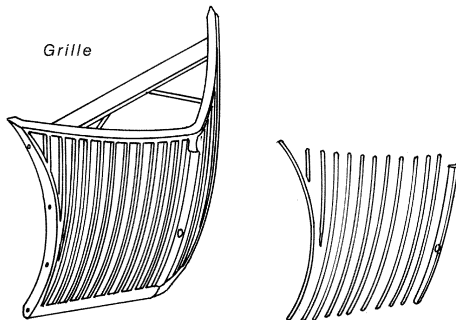

91A-8200-P	Replacement Grille with crank hole	850.00 ea
91A-8200-PN	Replacement Grille, no crank hole	850.00 ea
<i>Note: replacement grille is a fair quality import which requires effort for perfect fit. We strongly recommend fitting this part before paint or plating.</i>		
91A-8157	Grille center trim, w/crank hole, die cast, chrome	145.00 ea
91A-8332-K	Grille side trim, stainless, (24 pc set)	425.00 set
91A-20001-B	Grille verticle bar clips (82)	17.50 set
91A-20004	Grille side clips (8 pcs)	5.00 set

**1940 Standard
Hood Handles & Ornament**

Hood Ornament, chrome	
01A-8218-A	425.00 ea
Hood ornament mount spacers	
91A-8219-S	set (3) 25.00 set
Hood Handle	
01A-8215-A	Handle 85.00 ea
91A-2466	mount pin 5.00 ea
Hood front trim, chrome	
01A-8216-S	Lower 90.00 pr
01A-16604-S	"V8" 55.00 pr

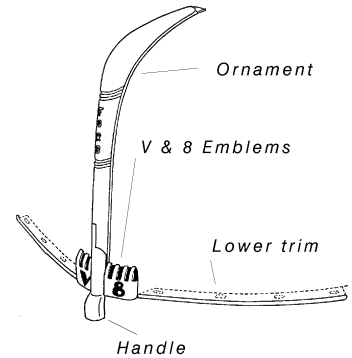

**1940 Standard
Hood Side Emblem**

91A-16606	"Ford"	32.50 ea
-----------	--------	----------



Hood Stainless Trim

01A-16736-A	Center trim strip, stainless, 1940 Standard	70.00 ea
91A-20003	Center strip mount clips (8 pcs)	5.00 set
01A-16722-B	Side trim strip, RH, stainless, 1940 Standard	not.avbl
01A-16723-B	Side trim strip, LH, stainless, 1940 Standard	not.avbl

1940 Standard Passenger Grille

Grille Center and Sides	
<i>Chrome center & black sides</i>	
01A-8200-AS	not.avbl
<i>Chrome center & sides</i>	
01A-8200-AC	not.avbl

Lower grille panel

<i>Plain</i>	
01A-8188-A	125.00 ea
<i>Chrome</i>	
01A-8188-C	not.avbl

Grille upper brace assembly

01A-8145-A	155.00 ea
------------	-----------

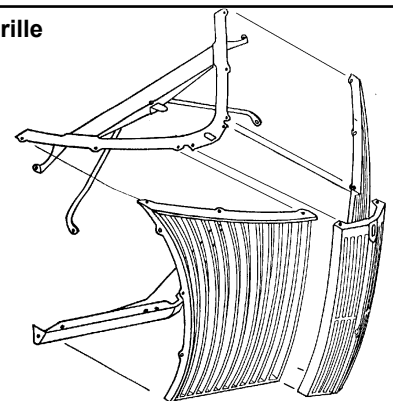

* Parts with price listed as "not.avbl" are not known to be available at this time, but are listed for reference.

1939 Deluxe, 1940 Standard and Deluxe Grille, Hood, Fenders and Running Boards, cont

1940 Deluxe

Hood Handle & Ornament

Hood ornament, chrome

01A-8218-D not.avbl

Ornament mt spacers

91A-8219-S set (3) 25.00 set

Hood handle

01A-8215-D Handle not.avbl

91A-2466 Mount pin 5.00 ea

Lower trim, stainless

01A-16868-S Inner 115.00 pr

01A-16954-S Outer 90.00 pr

01A-20002 Clips 7.50 set

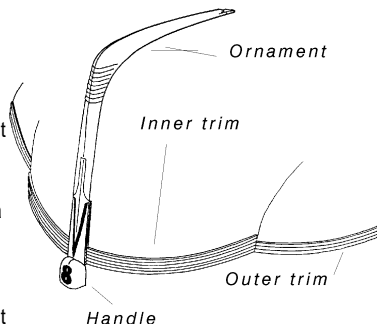

1940 Deluxe Hood Side Emblems

01A-16606 "Ford" 15.00 ea

01A-16607 "Deluxe" 15.00 ea



Hood Stainless Trim

01A-16736-B Center trim strip, stainless, 1940 Deluxe 70.00 ea

91A-20003 Center strip mount clips (8 pcs) 5.00 set

01A-16722-B Side trim strip, RH, stainless, 1940 Deluxe not.avbl

01A-16723-B Side trim strip, LH, stainless, 1940 Deluxe not.avbl

1940 Deluxe Passenger Grille

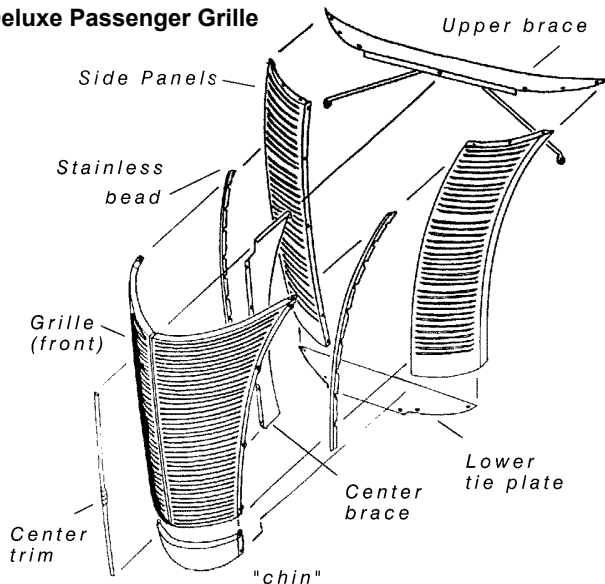

01A-8200-D Grille (front), chrome, includes center trim 700.00 set

01A-8200-DN Grille (front) chrome, w/rim, no crank hole not.avbl

01A-8418-S Grille center trim (3 pcs) 45.00 ea

01A-8418-SM Grille center trim, 1 pc, no crank hole 125.00 ea

01A-8211-B Grille front lower panel ("chin"), plain 70.00 ea

01A-8211-C Grille front lower panel ("chin"), chrome not.avbl

01A-8209 Grille center vertical brace 75.00 ea

01A-8182 Grille center/side stainless bead 35.00 pr

01A-16140-S Grille surround side panels not.avbl

01A-16856-K Grille surround trim (4 pcs) 100.00 set

01A-20001 Grille horizontal trim clips (16) 10.00 set

01A-8145-B Grille upper brace assembly 155.00 ea

01A-8434 Lower tie plate 17.50 ea



Grille to Radiator Shroud

Side baffle plates

91A-8104-S Steel 32.50 pr

Grille to crossmember shield

FSB3940P Fberglass 230.00 ea

91A-8240-B Steel 120.00 ea

Grille apron to frame bumpers

01A-16188 Set of 4 7.50 set

Grille upper shroud plate (street rod),

Stainless. Assists cooling by preventing air bypassing radiator over its top.

01A-8327-A 1939 Delxue 160.00 ea

1940 Standard

01A-8327-B 1940 Deluxe 160.00 ea

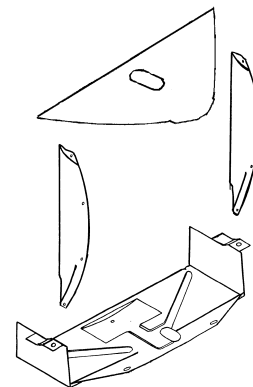

Hoods

Fiberglass outer panel fully supported by an inner steel support structure.



Ornaments and trim can be used

One piece outer with filled holes

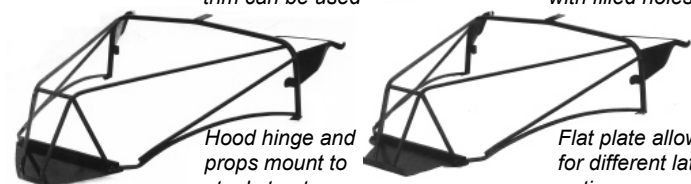

Hood hinge and props mount to steel structure

Flat plate allows for different latch options

HD39DP 1939 Deluxe & 1940 Standard Passenger 1500.00 ea

HD40DP 1940 Deluxe Passenger 1500.00 ea

Hood Hinges

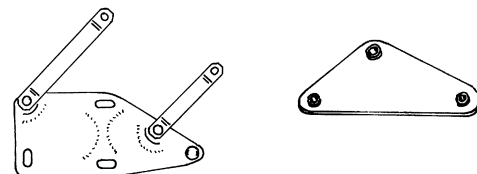

91A-16796/7 Hood hinges, plain 70.00 pr

91A-16796/7-SS Hood hinges, stainless 85.00 pr

78-16746/7 Hood Hinge to Cowl Pads, rubber 10.00 pr

91A-16796-HK Hood Hinge Bolts, includes safety wire, set of 4 7.50 ea

* Parts with price listed as "not.avbl" are not known to be available at this time, but are listed for reference.

**1939 Deluxe, 1940 Standard and Deluxe
Grille, Hood, Fenders and Running Boards, cont**

Hood Support Arms with Springs

Most 1939 Deluxe:

Uses shoulder bolt to hood and cowl

91A-16782/3	Plain	100.00	pr
91A-16782/3-SS	Stainless	95.00	pr

Most 1940:

Uses shoulder screw to hood.

Bottom bolts to cowl, has hinge

91A-16802/3	Plain	85.00	pr
91A-16802/3-SS	Stainless	100.00	pr

Replacement spring only:

91A-16789	Plain	10.00	ea
91A-16789-SS	Stainless	15.00	ea

Hood Support Shoulder Screws

01A-16782-MS	Plain	10.00	pr
01A-16782-MSS	Stainless	12.50	pr

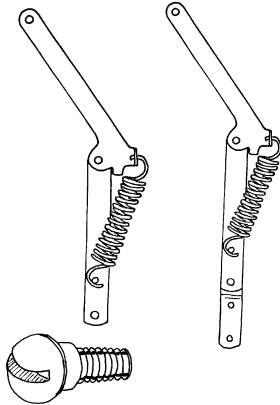

Hood Internal Latch Linkage and Brace Kit

For original steel hoods. Includes internal braces, handle to latch link, hood latch check, linkage springs, and clevis pins

01A-16674-A	Late 1939 Deluxe, 1940 Std, 1940-41 V8 Pickup	75.00	ea
<i>Braces can be used on early 1939 Deluxe</i>			
01A-16674-B	1940 Deluxe	75.00	ea

Handle to latch spring set (only)

91A-16781	Late 1939 Deluxe, 1940 Std, 1940-41 V8 Pickup	not.avbl	
01A-16781-D	1940 Deluxe	22.50	set

Note: Early 1939 have two small wire latch hooks, Late 1939 and 1940 have a single large latch hook.

Hood Latch Brace Mounting Hardware

01A-16774-BHK	1939 Deluxe, 1940 All, 1940-41 V8 Pickup	7.50	set
---------------	------------------------------------------	------	-----

Hood Safety Latch and Spring

91A-16892-B	Late 1939 with single large hood latch	not.avbl	
01A-16892-A	1940 Standard	65.00	ea
01A-16892-B	1940 Deluxe	65.00	ea

Hood Lacing and Bumpers

78-16740-S	Hood lacing on cowl, rubber	10.00	ea
91A-16761	Hood bumper set	15.00	kit

Front Fenders

Early 1939 Deluxe front fenders are different than Late 1939 Deluxe-1940 Passenger fronts. The 1940 front fits 1939 Deluxe perfectly. Unless you have one of each very few people will notice the difference.



RFF40P	RH Front, Late 1939-40 Style, fiberglass	700.00	ea
LFF40P	LH Front, Late 1939-40 Style, fiberglass	700.00	ea
RFI40A	RH inner fender, fiberglass	250.00	ea
LFI40A	LH inner fender, fiberglass	250.00	ea
01A-16082/3	Inner fenders, stamped steel	425.00	pr

Coupe, Sedan & Convertible Rear Fenders, Fiberglass



RFF3840P	RH: No taillight mount	550.00	ea
LRF3840P	LH: No taillight mount	550.00	ea
RFF3839P	RH: w/boss for 1939 taillight	550.00	ea
LRF3839P	LH: w/boss for 1939 taillight	550.00	ea
RFF40P	RH: w/boss for 1940 taillight	550.00	ea
LRF40P	LH: w/boss for 1940 taillight	550.00	ea

1940-41 Sedan Delivery

**Rear Fenders
Fiberglass**



Right:

RFF4041SD	550.00	ea
-----------	--------	----

Left:

LRF4041SD	550.00	ea
-----------	--------	----

Front Fender Support Yoke

Mounts to front frame crossmember and cross braces inner fenders. Our beefed up Street Rod version is formed of 1" steel tubing with the cross strap left off for extra engine pulley clearance.

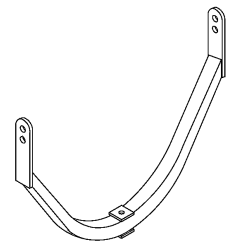

01A-16138-H	Yoke	200.00	ea
01A-16138-MB	Bolt/Spring	20.00	ea

**1939 Deluxe, 1940 Passenger, &
1940-41 1/2 Ton Pickup and Panel**

Front Fender Braces

*Stamped Steel
Baffle style brace.*

91A-16088/9	95.00	pr
-------------	-------	----

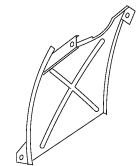

Rear Fender Brackets

78-16391	30.00	ea
----------	-------	----

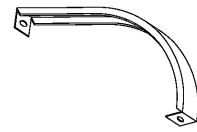

Inner Fender to Fender Flat Head Carriage Bolts

Used on 1939 Deluxe, 1940 Passenger and 1940-41 Pickup. Allows hood to clear bolt head.

01A-16005-MB	Set of 8	20.00	set
--------------	----------	-------	-----

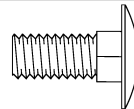

1939-1940 Fender Washer Sets

Rubber washers and large metal washers.

01A-16005-MW	Set of 30 each	22.50	set
--------------	----------------	-------	-----



* Parts with price listed as "not.avbl" are not known to be available at this time, but are listed for reference.

1939 Deluxe, 1940 Standard and Deluxe Grille, Hood, Fenders and Running Boards, cont

Rear Fender Clip Nuts

These are the infamous special nuts that clip into the rectangular holes in the wheelwells on 1940 Ford & Mercury.

01A-16009-K 18 pc set 40.00 set

Fender Welt

Black vinyl, 25 ft. length

48-16070-B 3/16" bead 17.50 ea

48-16070-D 1/4" bead 17.50 ea

Vinyl, clad w/stainless bead, 8 ft. length

48-16070-SS 7/32" bead 30.00 ea

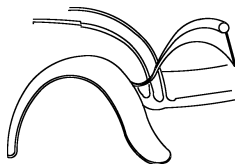

Vinyl, COLORED, Use part suffix to indicate color

Maroon: -MR, Caramel: -CR, Medium Blue: -BLM, Red: -RD, Dark Brown: -BRD, Dark Green: -GRD, White: -WH, Grey: -GY, Bright Orange: -OR, Yellow: -YL, Bright Red: -RR

48-16070-xx 25 ft length, Specify Color 40.00 ea

1939 Deluxe Passenger & 1940 Passenger, 1940-41 Sedan Delivery Running Boards

Fiberglass boards are very strong, over 1/4" thick. The steel boards require mild metalwork for perfect fit and are recommended only for use with rubber covers.



Fiberglass, smoothie style:

RRB40PS RH, smooth running board 500.00 ea

LRB40PS LH, smooth running board 500.00 ea

Fiberglass, with molded ribs to simulate original style

RRB40P RH, w/molded ribs 500.00 ea

LRB40P LH, w/molded ribs 500.00 ea

Steel boards and rubber covers:

91A-16450/1-BD Stamped steel, w/molded rubber cover not.avbl

01A-16450/1 Molded rubber replacement covers 300.00 pr

48-16455-MB 1935-48 Running board mount bolt 1.00 ea

78-16453-S Running board mount bolt set, 37-48 12.50 set

Teardrop Fender Skirts, Fiberglass

Excellent fiberglass reproductions of the aftermarket bubbled fender skirts that were so popular in the '50's. Includes locking arms to latch to the top of the fender, clamps to the bottom of the skirts to the front and rear of the wheel opening, stainless screws, and rubber seals.

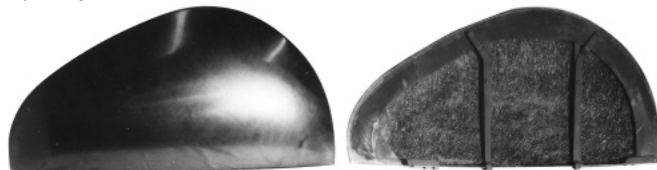

FST3740F Fender Skirts, fiberglass

800.00 pr

* Parts with price listed as "not.avbl" are not known to be available at this time, but are listed for reference.