

1936 Passenger Grille, Hood, Fenders and Running Boards

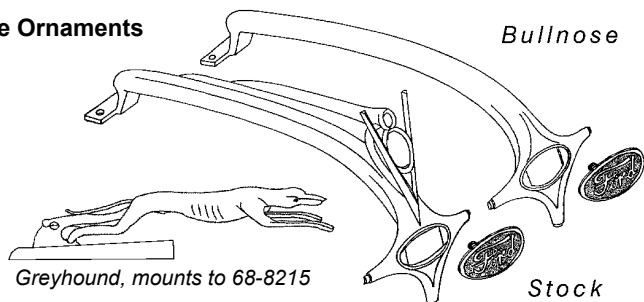

Grille Ornaments



| | | |
|------------|--|-----------|
| 68-8215 | Ornament, Stock V8 style, chrome plated | 105.00 ea |
| 68-8215-BN | Ornament, Bullnose style, chrome plated | 115.00 ea |
| 40-8212-B | Ford Emblem, Chrome with blue background | 20.00 ea |
| 68-8100-G | Accessory Greyhound, chrome | 90.00 ea |

Grille

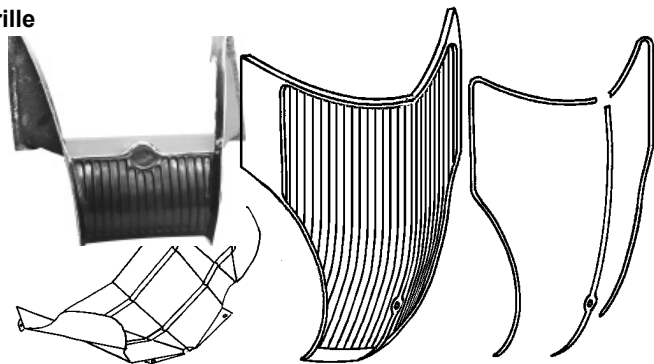

Grille:

Stamped Steel. A fair quality import which will require some effort for perfect fit. We strongly recommend fitting this part before paint or plating.

| | | |
|------------|------------------------------|-----------|
| 68-8200-P | Grille, plain, w/crank hole | 795.00 ea |
| 68-8200-PN | Grille, plain, no crank hole | 795.00 ea |

1936 Passenger Grille Trim

| | | |
|-----------|----------------------------|----------|
| 68-8157 | Center trim, stainless | 25.00 ea |
| 68-8184/5 | Side trim, stainless | 80.00 pr |
| 68-20001 | Center trim mounting clips | 5.00 set |
| 68-20002 | Outer trim mounting clips | 7.50 set |

1936 Passenger Grille Bug Screen

| | | |
|----------|--------------------------------------|----------|
| 68-18700 | Accessory bug screen, includes clips | 61.50 ea |
|----------|--------------------------------------|----------|

Grille Inner Panels

| | | |
|----------|-------------------------------------|-----------|
| GSP36P | Grille inner panel, fiberglass | 175.00 ea |
| 68-16554 | Grille to Crossmember Shield, steel | 70.00 ea |

Hood

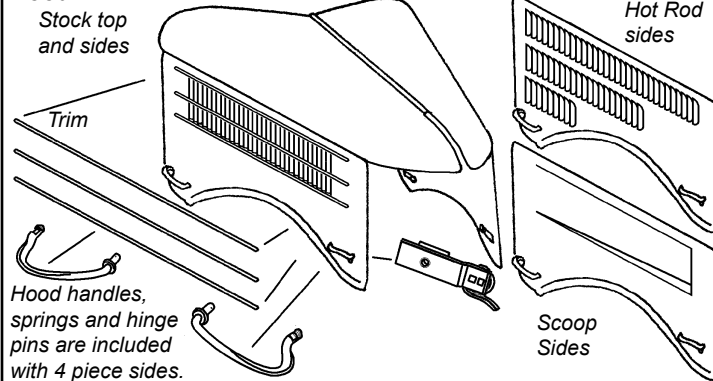

| Hood Parts | 4 Piece | | 3 Piece | |
|------------------------|------------|-----------|------------|-----------|
| Top | | | not.avbl | not.avbl |
| Sides, Stock louvers | | | not.avbl | not.avbl |
| Sides, Hot Rod Louvers | 68-16712-H | 400.00 pr | 68-16713-H | 400.00 pr |
| Sides, Plain | 68-16712-P | 400.00 pr | 68-16713-P | 400.00 pr |
| Sides, Scoop | 68-16712-S | 675.00 pr | 68-16713-S | 675.00 pr |

Hood Side Trim

| | | |
|------------|---|-----------|
| 68-16722-S | Side trim, stainless, set of 6 with clips | 95.00 set |
| 68-20004 | Side trim clip set (32 pcs) | 7.50 set |

Hood Handles and Springs

| | | |
|--------------|---------------------------------------|------------|
| 40-16636-BR | Handle, RH front, LH rear, bronze | 15.00 ea |
| 40-16636-BL | Handle, LH front, RH rear, bronze | 15.00 ea |
| 48-16644/5-B | Handles, set of 4, polished stainless | 170.00 set |
| 40-16637-BR | Bracket & Spring, RH front, LH rear | 25.00 ea |
| 40-16637-BL | Bracket & Spring, LH front, RH rear | 25.00 ea |

Hood Hinges (for 4 piece hoods)

Hinge Brackets:

| | | |
|---------|-----------------|----------|
| B-8220 | Rear, stainless | 12.50 ea |
| 68-8226 | Front, plain | 7.50 ea |

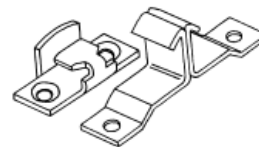

Center Hinge Strip

| | | |
|----------|----------------|----------|
| 40-16632 | stainless, 33" | 17.50 ea |
|----------|----------------|----------|

Side panel hinge rods

| | | |
|------------|----------------|----------|
| 68-16631-S | stnls, 34 1/2" | 17.50 pr |
|------------|----------------|----------|

Hood Lacing on Grille or Cowl

We recommend fabric or hard rubber lacing for 4 piece hoods, foam rubber should only be used with 3 piece hoods.

| | | |
|------------|---|----------|
| 68-16739-S | Grille: 1936 Passenger, rubber w/rivets | 7.50 ea |
| 68-16740-S | Cowl: 1936 Passenger, fabric, w/screws | 15.00 ea |
| HR-16739 | Foam rubber, 3/8" x 3/16" (most rad shells) | 10.00 ea |
| HR-16740 | Foam rubber, 5/8" x 3/8" (most cowls) | 12.50 ea |

1928-36 Accessory Hood Supports, Stainless Steel

| | | |
|-------------|--------------------------------|----------|
| HR-16780-SS | Mount to radiator support rods | 45.00 ea |
|-------------|--------------------------------|----------|

1936 Pass Hood Latch and Bumper Brackets on Fenders

| | | |
|-------------|---|----------|
| 68-16628-K | Front latch bracket on fender, plain | not.avbl |
| 68-16628-KS | Front latch bracket on fender, stainless | 45.00 pr |
| 68-16759-K | Rear hood bumper bracket on fender, plain | 25.00 pr |
| 68-16759-KS | Rear hood bumper bracket on fender, stainless | 35.00 pr |

Hood Rubber Bumper Sets

| | | |
|----------|----------------------------------|-----------|
| 68-16761 | 1936 Passenger (w/corner rubber) | 25.00 set |
|----------|----------------------------------|-----------|

* Parts with price listed as "not.avbl" are not known to be available at this time, but are listed for reference.

1936 Passenger Grille, Hood, Fenders and Running Boards, cont

Passenger Front Fenders, Fiberglass



| | | |
|--------|----------------------------|-----------|
| RFF36P | RH Front fender | 550.00 ea |
| LFF36P | LH Front fender | 550.00 ea |
| RFE36P | RH Fender/grille extension | 175.00 ea |
| LFE36P | LH Fender/grille extension | 175.00 ea |
| RFI36P | RH Inner fender | 150.00 ea |
| RFI36P | LH Inner fender | 150.00 ea |
| REI36P | RH Extension inner panel | 50.00 ea |
| LEI36P | LH Extension inner panel | 50.00 ea |

Front Fender Extension

Stainless Beads

This is the formed stainless welt that goes between front fender and front fender extension; 4 pc set.

68-16035 50.00 set

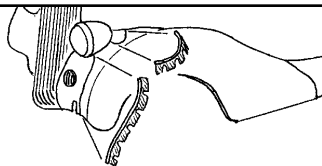

Front Fender Horn Grilles

Horn Grille

68-16156-S stainless 17.50 ea

Horn grille rubber pads:

68-16156-P rubber 12.50 pr

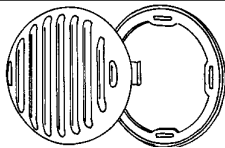

Fender Brackets and Mounting

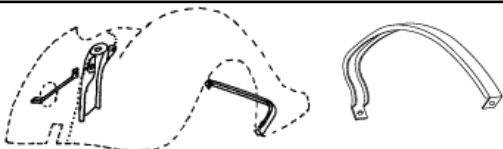

| | | |
|-------------|--|----------|
| 68-16025-R | Front fender/headlight support, RH | 60.00 ea |
| 68-16025-L | Front fender/headlight support, LH | 60.00 ea |
| 48-16067-R | Front support bracket to crossmember strut, RH | 10.00 ea |
| 48-16067-L | Front support bracket to crossmember strut, LH | 10.00 ea |
| 48-16094 | Front fender skirt bracket, RH or LH | 20.00 ea |
| 48-16391 | Rear fender bracket, RH or LH | 27.50 ea |
| 48-16008-SK | Fender washer set, 28 pieces | 10.00 ea |
| AH-3145 | Cage nut, 5/16-24 | 1.50 ea |

Fender Welt

Black vinyl, 25 ft. length

48-16070-B 3/16" bead 17.50 ea

48-16070-D 1/4" bead 17.50 ea

Vinyl, clad w/stainless bead, 8 ft. length

48-16070-SS 7/32" bead 22.50 ea

Vinyl, COLORED, Use part suffix to indicate color

Maroon: -MR, Caramel: -CR, Medium Blue: -BLM, Red: -RD, Dark Brown: -BRD, Dark Green: -GRD, White: -WH, Grey: -GY, Bright Orange: -OR, Yellow: -YL, Bright Red: -RR

48-16070-xx 25 ft length, Specify Color 40.00 ea

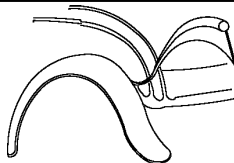

Coupe, Roadster,

Cabriolet

Rear Fenders,

Fiberglass

Right: RRF36CR 425.00 ea

Left: LRF36CR 425.00 ea



Sedan & Phaeton

Rear Fenders,

Fiberglass

Right: RRF36SPH 425.00 ea

Left: LRF36SPH 425.00 ea



Station Wagon

& Sedan Delivery

Rear Fenders,

Fiberglass

Trim inner flange of fender to fit Sedan Delivery

Right: RRF3539SD 425.00 ea

Left: LRF3539SD 425.00 ea



Teardrop Fender Skirts, Fiberglass

Excellent fiberglass reproductions of the aftermarket bubbled fender skirts that were so popular in the '50's. Includes locking arms to latch to the top of the fender, clamps to the bottom of the skirts to the front and rear of the wheel opening, stainless screws, and rubber seals.



FST3536F Fender Skirts, fiberglass 500.00 pr

1935-36 Passenger Running Boards

Fiberglass, smoothie style

Fiberglass boards are very strong, over 1/4" thick.



These have the proper arch for excellent fit and appearance

| | | |
|-----------|--------------------------|-----------|
| RRB3536PS | RH, smooth running board | 400.00 ea |
| LRB3536PS | LH, smooth running board | 400.00 ea |

Steel boards and rubber covers:

Steel boards with vulcanized covers are excellent quality and fit.

| | | |
|---------------|------------------------------------|------------|
| 48-16450/1-BD | Steel boards w/molded rubber cover | 1175.00 pr |
| 48-16450/1 | Molded rubber replacement covers | 225.00 pr |
| 48-16455-MB | 1935-48 Running board mount bolt | 1.00 ea |

Running Board Moldings

Stainless
48-16462-S 95.00 pr



* Parts with price listed as "not.avbl" are not known to be available at this time, but are listed for reference.