

1933-34 Commercial Grille, Hood, Fenders and Running Boards

Unless noted, fits 112" wb Pickup and Panel, and Big Trucks

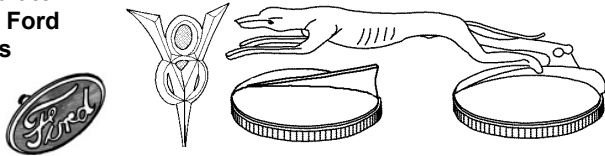

1933 Radiator Cap and Ford Emblems



B-8212	Ford Emblem, chrome w/blue background	20.00 ea
40-8217-A	V8 Emblem, chrome	25.00 ea
46-8100-A	Radiator Cap (includes internal guts), chrome	20.00 ea
B-8100-G	Greyhound Radiator Cap, (1932, works on PU) internal guts not included.	not.avbl
B-8100-K	Radiator cap internal guts	10.00 set

1934 Grille Ornament & Radiator Cap

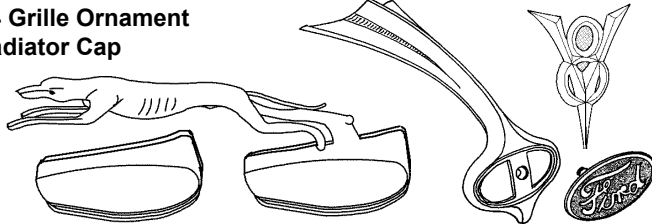

46-8215	Grille ornament	32.50 ea
B-8212	Ford emblem	20.00 ea
40-8217-A	V8 Emblem, chrome	25.00 ea
46-8100	Radiator Cap (stock), includes internal guts	20.00 ea
46-8100-AG	Greyhound Radiator Cap, guts not included	not.avbl
B-8100-K	Radiator cap internal guts	10.00 set

Grille

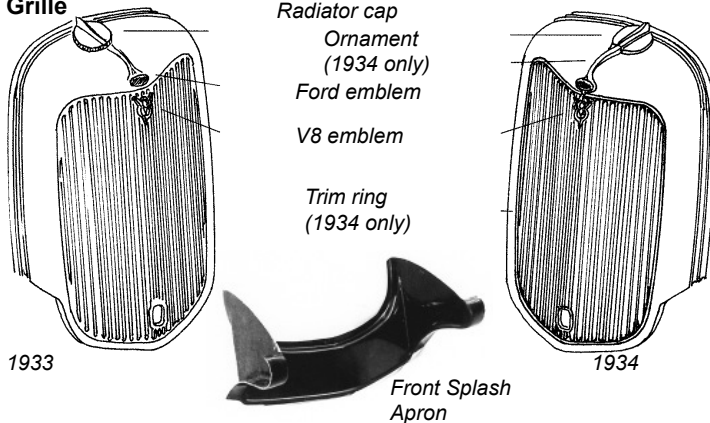

46-8200-A	1933 Grille	not.avbl
46-8200-B	1934 Grille	not.avbl
46-8234	1934 Trim ring	125.00 ea
68-20004	Grille trim clip set	7.50 set
46-8094-BS	Grille to radiator spacers and bolts	40.00 ea
A-8201-BM	Grille to spacer bracket bolts only	2.00 set
FSA3334PU	Front Splash Apron, Fiberglass	140.00 ea

Stock and Street Rod

Hoods

Steel hoods by Rootlieb.

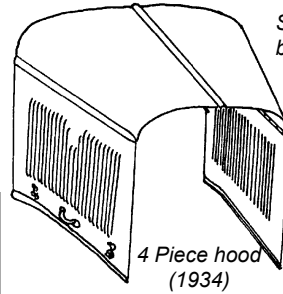

4 Piece hood (1934)

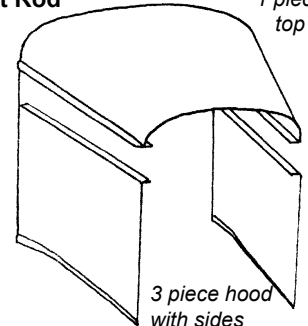

3 piece hood with sides

Hood top includes passenger type center hinge. (Stock hinge not available on top panels) Side panels are complete with hood handles and hinge rods.

Hood top can be used as a top panel only. Side panels do not have handles. Hood hinges and top panel braces not included, sold separately.

Hood Tops

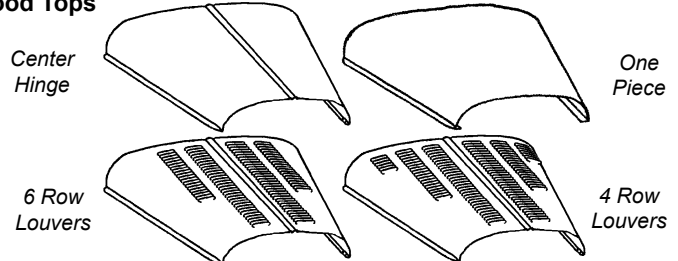

Center Hinge	One Piece			
6 Row Louvers	4 Row Louvers			
4 Piece	3 Piece (1 pc top)			
Top, Plain	46-16710-2	325.00 ea	46-16710-3	325.00 ea
Top, Louvered, (4 rows)	46-16710-2L6	500.00 ea	46-16710-3L4	450.00 ea

Hood Sides

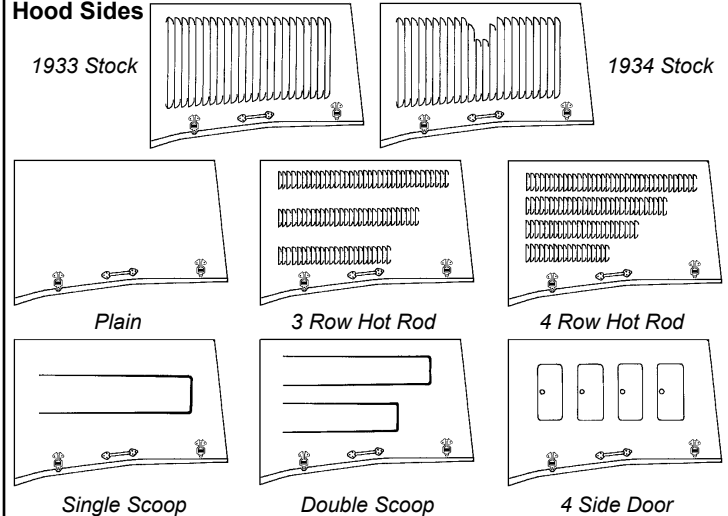

1933 Stock	1934 Stock			
Plain	3 Row Hot Rod	4 Row Hot Rod		
Single Scoop	Double Scoop	4 Side Door		
4 Piece	3 Piece (1 pc top)			
Sides, 1933 Stock style	46-16712-A	325.00 pr	46-16713-A	270.00 pr
Sides, 1934 Stock style	46-16712-B	325.00 pr	46-16713-B	270.00 pr
Sides, Hot rod (3 row)	46-16712-H	325.00 pr	46-16713-H	270.00 pr
Sides, Hot rod (4 row)	46-16712-H4	325.00 pr		
Sides, Plain	46-16712-P	325.00 pr	46-16713-P	270.00 pr
Sides, 4 door	46-16712-D	850.00 pr		
Sides, Single scoop	46-16712-S1	650.00 pr	46-16713-S1	600.00 pr
Sides, Double scoop	46-16712-S2	975.00 pr	46-16713-S2	925.00 pr

* Parts with price listed as "not.avbl" are not known to be available at this time, but are listed for reference.

1933-34 Commercial Grille, Hood, Fenders and Running Boards, cont

1934 Pickup Hood Side Emblems

46-16606	"Ford"	55.00 ea
46-16607	"V8"	17.50 ea



Hood Hinge Brackets

Original type: Stainless, use with original interlocking center hood hinge.

46-8220	Front	22.50 ea
46-8221	Rear	22.50 ea

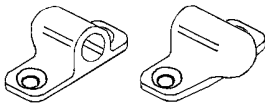

Hood V8 Center Hinge Brackets

Use with Rootlieb Hood w/V8 hinge

Front or Rear:

Chrome plated

B-8220	12.50 ea
--------	----------

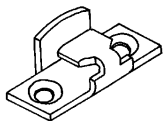

1928-36 Accessory Hood Supports, Stainless Steel

HR-16780-SS	Mount to radiator support rods	45.00 ea
-------------	--------------------------------	----------

Hood Latches (original type)

Hood Latches

B-16750	Plain	12.50 ea
B-16750-SS	Stainless	20.00 ea

Hood Latch Mount Screw Set

B-16750-MS	Stainless Steel	5.00 set
------------	-----------------	----------

Hood Latch to Fender Pads, Rubber

B-16750-PAD	oblong type	17.50 ea
B-35630	oval type	5.00 pr

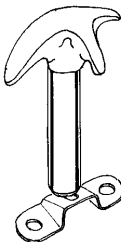

Hood Side Hardware and Bumpers

A-16636	Hood side handles, Plain, w/rivets	25.00 pr
A-16636-SS	Hood side handles, Stainless, w/screws	30.00 pr
B-16751-S	Hood latch catch brackets, set of 4 w/rubbers	30.00 set
B-16751-SS	Hood latch catch set, stainless	40.00 set
A-16751-RS	Dummy (threaded) rivets, chrome, set of 20	5.00 set
B-16761	Hood bumper set	22.50 set
B-16718-S	Center bumper bracket (mounts to fender)	not.avbl



Hinge and Braces for 3-Piece Hoods

Top Panel Braces

3/8" round steel braces provide extra support. This minimizes flexing and helps to avoid cracking paint and smooths operation of hidden hinges.

46-16714-DF	Braces	90.00 set
-------------	--------	-----------

Hidden hinge and latch kit:

By DF Metalworks. Includes hinges, latches, and side panel lower alignment pins. Hardware and instructions are included.

B-16711-DF	LH Open	375.00 set
B-16711-DF2	2 Way Open	475.00 set

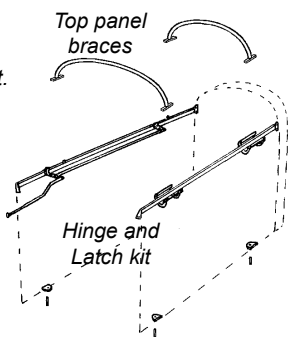

Hood Lacing

50-16739-S	Grille, fabric w/rivets	12.50 ea
48-16740-S	Cowl, fabric w/screws	15.00 ea
HR-16739	Foam rubber, 3/8" x 3/16" (most rad shells)	10.00 ea
HR-16740	Foam rubber, 5/8" x 3/8" (most cowls)	12.50 ea

Fenders, Fiberglass

Front fenders fit 1933-34 Pickup, Panel, and Trucks.



RFF3334PU	RH Front, plain	400.00 ea
LFF3334PU	LH Front, plain	400.00 ea
RFF3334PU6	RH Front w/6" spare tire well	500.00 ea
LFF3334PU6	LH Front w/6" spare tire well	500.00 ea
RFF3334PU8	RH Front w/8" spare tire well	500.00 ea
LFF3334PU8	LH Front w/8" spare tire well	500.00 ea
RRF3334PU	RH Rear: Pickup & Panel	300.00 ea
LRF3334PU	LH Rear: Pickup & Panel	300.00 ea

Pickup rear fenders can be converted to 112 wb (1/2 ton) Panel rear fenders by trimming inside mounting flanges to match the panel body.

Front Fender Bracket and Bolts

Fender Bracket

46-16025-R	RH	not.avbl
46-16025-L	LH	not.avbl

Front fender to fender bracket:

B-16026-S2	1/2" long	2.50 pr
------------	-----------	---------

Front fender to frame (slotted)

A-16027-SS	Set of 4	2.50 set
------------	----------	----------

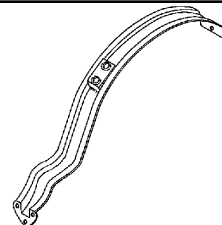

Rear Wheelwell Studs

Large head fender mount bolt, spot welds to wheelwell of pickup box.

AH-1173	Set of 4	2.50 set
---------	----------	----------

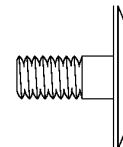

Fender Welt

Black vinyl, 25 ft. length

48-16070-B	3/16" bead	17.50 ea
48-16070-D	1/4" bead	17.50 ea

Vinyl, clad w/stainless bead, 8 ft. length

48-16070-SS	7/32" bead	22.50 ea
-------------	------------	----------

Vinyl, COLORED, Use part suffix to indicate color

Maroon: -MR, Caramel: -CR, Medium Blue: -BLM, Red: -RD, Dark Brown: -BRD, Dark Green: -GRD, White: -WH, Grey: -GY, Bright Orange: -OR, Yellow: -YL, Bright Red: -RR

48-16070-xx	25 ft length, Specify Color	35.00 ea
-------------	-----------------------------	----------

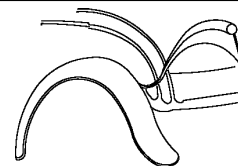

Running Boards, fit 1/2 ton only

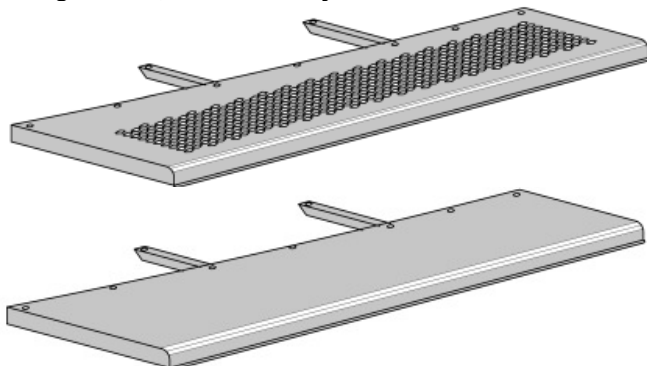

46-16450-S	Stamped steel, w/stock diamond tread	375.00 pr
46-16450-SM	Stamped steel, smooth	300.00 pr

* Parts with price listed as "not.avbl" are not known to be available at this time, but are listed for reference.