

**1938-41 Commercial Grille, Hood, Fenders and Running Boards, cont**



**1938-39 1/2 Ton and Truck Grille**

81C-8200	Grille, 1938	not.avbl
91C-8200	Grille, 1939	not.avbl
81C-8213	Grille center V8 emblem, 1938, chrome	100.00 ea
81C-8157	Grille center trim, 1938	not.avbl
91C-8157	Grille center trim, 1939	not.avbl
81C-8184	Grille outer trime ring, 1938-39	not.avbl

**1938-39 1/2 Ton and Truck Radiator Shroud**

81C-8084/5-B	Radiator side panels	not.avbl
81C-8240-B	Grille inner baffel	not.avbl
81C-16550	Grille to crossmember shield	not.avbl

**1938-39 1/2 Ton and Truck Hood**

81C-16710-A	Hood top	not.avbl
81C-16618-A	Hood side panel RH	not.avbl
81C-16619-A	Hood side panel LH	not.avbl
81A-16750-RK	Hood side panel mounting studs & brackets	45.00 ea

**1938-39 1/2 Ton and Truck Hood Handles & Ornaments**

	1938		1939	
Hood Handle	81C-8215-A	not.avbl	91C-8215	not.avbl
Handle Base	81C-8218-A	not.avbl	91C-8218	not.avbl
Base Gasket	81C-8227-A	not.avbl	91C-8227	not.avbl

**1938-39 1/2 Ton and Truck Hood Emblem**

"Ford 85"

81C-16606 not.avbl



**1938-39 1/2 Ton and Truck Hood Latch**

81A-16628	Hood latch cam	not.avbl
81A-16650	Hood handle tension spring	not.avbl

**1938-39 1/2 Ton and Truck Hood Hinge**

**Hood Hinge Brackets**

81C-16796-S	Plain	not.avbl
81C-16796-SS	Stainless	not.avbl

**Hood Hinge Bolts, w/safety wire**

91A-16796-HK	Set of 4	7.50 ea
--------------	----------	---------

\* Parts with price listed as "not.avbl" are not known to be available at this time, but are listed for reference.

## 1938-41 Commercial Grille, Hood, Fenders and Running Boards, cont



### Hood Support Arms

#### 1938 Prop (ratchet style)

78-16782 Props (ratchet type) not.avbl

#### 1939 Prop (spring arm style)

91A-16782/3 Plain 55.00 pr

91A-16782/3-SS Stainless 90.00 pr

#### 1939 Replacement spring only:

91A-16789 Plain 7.50 ea

91A-16789-SS Stainless 12.50 ea

#### Hood Support Shoulder Screws

01A-16782-MS Plain 7.50 pr

01A-16782-MSS Stainless 12.50 pr

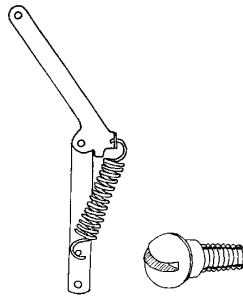

### 1938-39 1/2 Ton and Truck Hood Lacing & Bumpers

81C-16739-S Hood lacing on grille, Rubber 10.00 ea

78-16740-S Hood lacing on cowl 10.00 ea

81A-16761 Hood rubber bumper set 22.50 set

### 1938-39 1/2 Ton Pickup & Panel Front Fender, Fiberglass

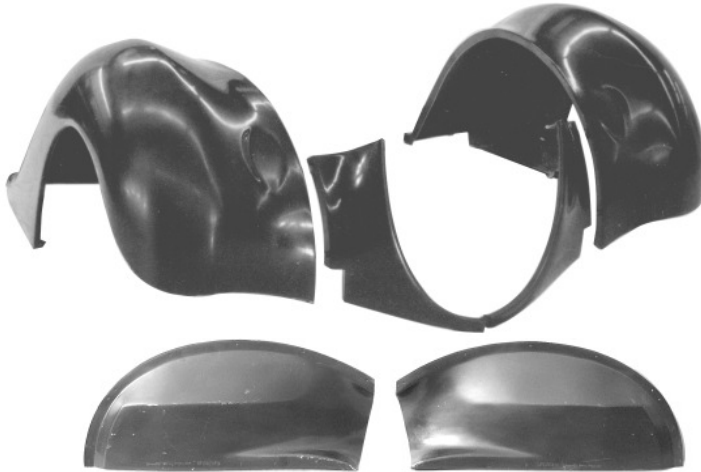

RFF3839PU RH front, 1938-39 Pickup 550.00 ea

LFF3839PU LH front, 1938-39 Pickup 550.00 ea

RFE3839PU RH fender/grille extension 175.00 ea

LFE3839PU LH fender/grille extension 175.00 ea

RFI3839PU RH Inner front fender 200.00 ea

LF3839PU LH Inner front fender 200.00 ea

### 1938-39 1/2 Ton Pickup & Panel Front Fender Brackets

	<b>RH</b>		<b>LH</b>	
Fender/Headlight bkt	81C-16025-R	not.avbl	81C-16025-L	not.avbl
Fender bkt/frame brace	81C-16067-R	not.avbl	81C-16067-L	not.avbl
Fender skirt brace	81C-16094	25.00 ea	81C-16094	25.00 ea

### 1940-41

#### 1/2 Ton

### Hood Handles & Ornaments

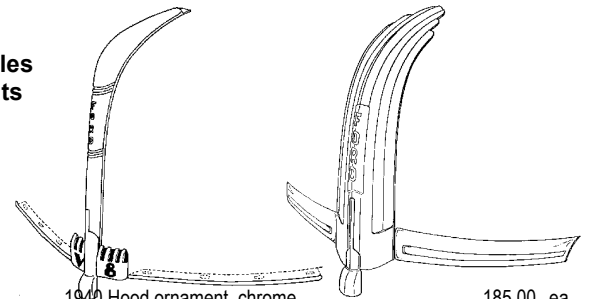

01C-8218-A 1940 Hood ornament, chrome 185.00 ea

11C-8218 1941 Hood ornament, chrome not.avbl

91A-8219-S 1940-41 Hood ornament mount spacers (3) 17.50 set

01C-8215 1940 Hood handle, chrome 22.50 ea

11C-8215 1941 Hood handle, chrome not.avbl

91A-2466 1940-41 Handle to Ornament Pin 5.00 ea

01A-8216-S 1940 Hood lower trim, stainless not.avbl

11C-8264-S 1941 Hood lower trim, chrome 200.00 pr

01A-16604-S 1940 Hood V & 8 emblems 55.00 pr

### 1940-41 1/2 Ton Grille

#### Chrome center & black sides

01A-8200-AS 725.00 ea

#### Chrome center & sides

01A-8200-AC 825.00 ea

#### Lower grille panel, plain

01A-8188-A 115.00 ea

#### Lower grille panel, plain

01A-8188-C 115.00 ea

#### Grille upper brace assembly

*Does not fit 1941 6 cylinder*

01A-8145-A 145.00 ea

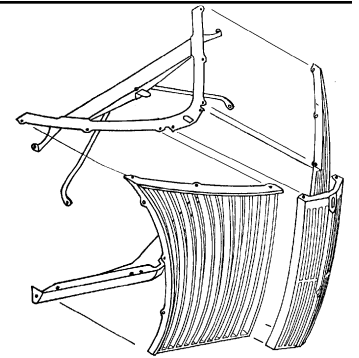

### 1940-41 1/2 Ton Grille to Radiator Shroud

#### Side baffle plates

91A-8104-S Steel 32.50 pr

#### Grille to crossmember shield

FSB3940P Fiberglass 140.00 ea

91A-8240-B Steel 110.00 ea

#### Grille apron to frame bumpers

01A-16188 Set of 4 5.00 set

#### Grille upper shroud plate (street rod),

*Assists cooling, prevents air bypassing radiator.*

01A-8327-A Stainless 145.00 ea

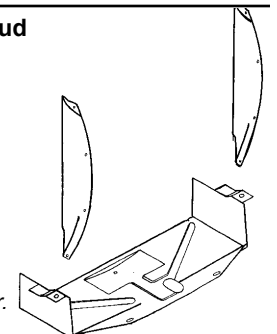

\* Parts with price listed as "not.avbl" are not known to be available at this time, but are listed for reference.

**1938-41 Commercial Grille, Hood, Fenders and Running Boards, cont**

**1940-41  
1/2 Ton  
Hood**



HD4041PU      Fiberglass with steel inner structure      1200.00 ea

**1940-41 1/2 Ton Hood Center Trim Strip**

01C-16736      Center strip, 1940-41, stainless      65.00 ea  
91A-20003      Center trim strip mounting clips, 1940-41      5.00 set

**1940-41 1/2 Ton Hood Latch Linkage & Safety Catch**

01A-16781-S      Hood latch linkage spring set (V8-85 only)      10.00 set  
01A-16892-A      Hood safety catch      50.00 ea  
01A-16674-A      Hood latch release lever      12.50 ea  
01A-16674-HK      Clevis pins & washers for release lever      10.00 ea  
01A-16718      Hood latch check on front brace      12.50 ea  
01A-16774-BHK      Hood front brace mount hardware      7.50 set

**1940-41 Hood Hinges and Supports**

**Hood Hinges:**

99A-16796-S      Plain      35.00 pr  
99A-16796-SS      Stainless      55.00 pr

**Hood Hinge Bolts w/safety wire**

91A-16796-HK      Set of 4      7.50 ea

**Hood Support Arms with Springs**

*Uses shoulder bolt top and bottom*

91A-16782/3      Plain      55.00 pr  
91A-16782/3-SS      Stainless      90.00 pr

**Spring only (replacement):**

91A-16789      Plain      7.50 ea  
91A-16789-SS      Stainless      12.50 ea

**Hood Support Shoulder Screws**

01A-16782-MS      Plain      7.50 pr  
01A-16782-MSS      Stainless      12.50 pr

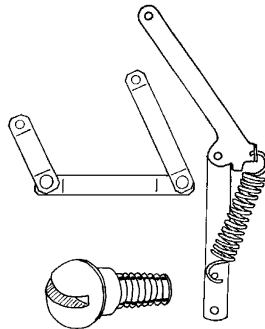

**1940-41 1/2 Ton Hood Lacing & Hood Bumpers**

78-16740-S      Hood lacing on cowl, rubber      10.00 ea  
01C-16761      Hood bumper set      15.00 ea

**1940-41 Hood Side "Ford" Emblem**

1940 1941



91A-16606      1940      32.50 ea  
11C-16606      1941      22.50 ea

**1940-41 1/2 Ton Front Fenders, Fiberglass**



RFF4041PU      RH Front      550.00 ea  
LFF4041PU      LH Front      550.00 ea  
RF140A      RH inner fender, fiberglass      200.00 ea  
LF140A      LH inner fender, fiberglass      200.00 ea  
01A-16082/3      Inner fenders, stamped steel      350.00 pr

**1940-41 1/2 Ton Front Fender Support Yoke**

*Mounts to front frame crossmember and cross braces inner fenders. Our beefed up Street Rod version is formed of 1" steel tubing with the cross strap left off for extra engine pulley clearance.*

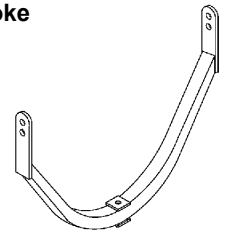

01A-16138-H      Yoke      125.00 ea  
01A-16138-MB      Bolt/Spring      20.00 ea

**1940-41 1/2 Ton Front Fender Braces & Special Bolts**

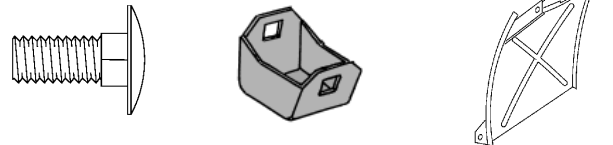

91A-16088/9      Behind fender "Baffle" brace, stamped steel      100.00 pr  
01C-16094      Fender to firewall brace      35.00 pr  
01A-16005-MB      Inner fender/fender shallow carriage bolts (8)      10.00 set

**1938-41 1/2 Ton Rear Fenders, Fiberglass**

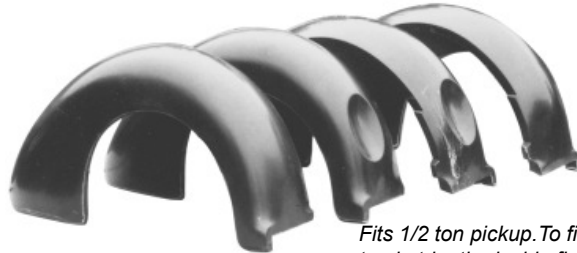

*Fits 1/2 ton pickup. To fit the panel truck, trim the inside flange.*

RRF3841PU      RH: Plain (no tire dimple)      500.00 ea  
LRF3841PU      LH: Plain (no tire dimple)      500.00 ea  
RRF3841PUW      RH: w/dimple for spare tire      500.00 ea  
LRF3841PUW      LH: w/dimple for spare tire      500.00 ea

**1/2 Ton Running Board To Bed Aprons, stamped steel**

*Mount between box and running boards in front of rear fenders.*

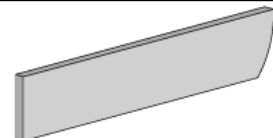

81C-16535-S      37.50 pr

\* Parts with price listed as "not.avbl" are not known to be available at this time, but are listed for reference.

## 1938-41 Commercial Grille, Hood, Fenders and Running Boards, cont

### 5/16-24 Cage Nuts

Welded to body and frame for  
fender and running board mounting.

AH-3145 Cage nut 1.50 ea

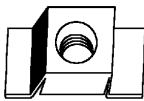

### Rear Fender Brackets & Bed Studs

#### 1/2 Ton Rear fender brackets

81C-16391 25.00 ea

#### Bed Fender Studs, set of 4

AH-1173 2.50 set

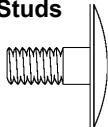

### 1939-1940 Fender Washer Sets

Rubber washers and large metal washers.

01A-16005-MW Set of 30 each 15.00 set

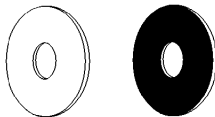

### Fender Welt

#### Black vinyl, 25 ft. length

48-16070-B 3/16" bead 17.50 ea

48-16070-D 1/4" bead 17.50 ea

#### Vinyl, clad w/stainless bead, 8 ft. length

48-16070-SS 7/32" bead 22.50 ea

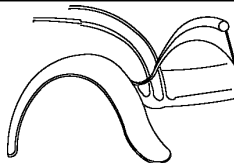

#### Vinyl, COLORED, Use part suffix to indicate color

Maroon: -MR, Caramel: -CR, Medium Blue: -BLM, Red: -RD, Dark Brown:  
-BRD, Dark Green: -GRD, White: -WH, Grey: -GY, Bright Orange: -OR,  
Yellow: -YL, Bright Red: -RR

48-16070-xx 25 ft length, Specify Color 35.00 ea

### 1/2 Ton Running Boards

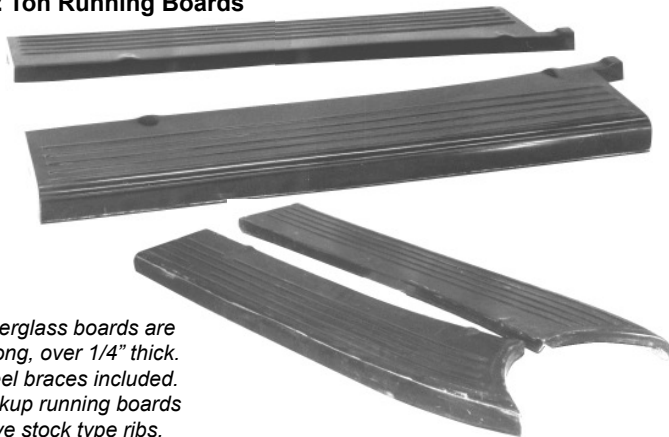

Fiberglass boards are  
strong, over 1/4" thick.  
Steel braces included.  
Pickup running boards  
have stock type ribs.

RRB3839PU	1938-39 RH Running board, fiberglass	400.00 ea
LRB3839PU	1938-39 LH Running board, fiberglass	400.00 ea
81C-16450-S	1938-39 Running Boards, steel	700.00 pr
RRB4041PU	1940-41 RH Running board, fiberglass	400.00 ea
LRB4041PU	1940-41 LH Running board, fiberglass	400.00 ea
01C-16450-S	1940-41 Running boards, steel	700.00 pr

### Teardrop Fender Skirts, Fiberglass

Excellent fiberglass reproductions of the aftermarket bubbled fender skirts  
that were so popular in the '50's. Includes locking arms to latch to the top  
of the fender, clamps to the bottom of the skirts to the front and rear of the  
wheel opening, stainless screws, and rubber seals.

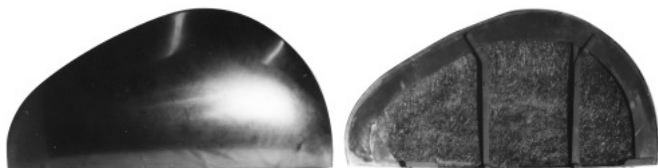

FST3740F Fender Skirts, fiberglass 650.00 pr

\* Parts with price listed as "not.avbl" are not known to be available at this time, but are listed for reference.