

1926-31 Bumpers

1928-31 Bumper Face Bars

Full width bars were used on front, can be used on rear. Clamps and end hardware shown are not included with bumper face bars.

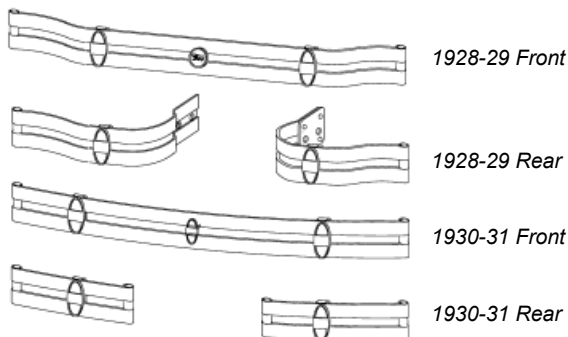

Full Width Face Bars

| | | | |
|-------------|-----------------------------------|--------|-----|
| A-17757-CSS | 1928-29, With end eyes, stainless | 375.00 | set |
| A-17757-DSS | 1930-31, 61" wide, stainless | 375.00 | set |

Rear Bumperette Bar Sets

| | | | |
|-------------|--------------------|--------|-----|
| A-17784-CSS | 1928-29, Stainless | 400.00 | set |
| A-17784-DSS | 1930-31, Stainless | 375.00 | set |

1926-31 Bumper Clamps and End Bolts:

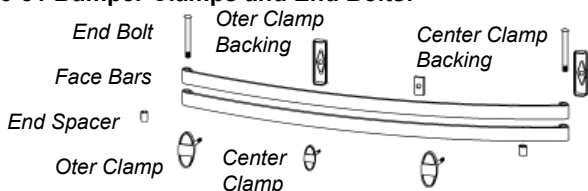

Outer Bumper Clamps

| | | | |
|------------|-----------------------------------|-------|----|
| T-17758 | 1926-27 Outer clamp, black | 12.50 | ea |
| T-17758-C | 1926-27 Outer clamp, chrome | 15.00 | ea |
| A-17758-CF | 1928-30 Clamp, steel, chrome | 22.50 | ea |
| A-17758-DF | 1930-31 Clamp, steel w/stls cover | 12.50 | ea |

Outer Bumper Clamp Backing Plates

| | | | |
|-----------|-------------------------|------|----|
| A-17756-B | 1929-31, Stamped, plain | 7.50 | ea |
|-----------|-------------------------|------|----|

Center Bumper Clamps

Steel with stainless cover; includes backing plate.

| | | | |
|-----------|--------------------------------|-------|----|
| A-17762-A | 1927 Round, "Ford made in USA" | 12.50 | ea |
| A-17762-B | 1927-28 Round, "Ford" | 12.50 | ea |
| A-17762-C | 1928-31 Oval, no script | 10.00 | ea |

Bumper End Bolts & Spacers

| | | | |
|-----------|-----------------------|-------|----|
| A-17834 | End bolt, plain | 7.50 | ea |
| A-17834-C | End bolt, stainless | 12.50 | pr |
| A-17759 | End spacer, plain | 2.50 | pr |
| A-17759-C | End spacer, stainless | 5.00 | ea |

Front Bumper Brackets



| | | | |
|--------------|--------------------------------------|--------|----|
| A-17754-AS | 1928-29, stock style, plain | 65.00 | pr |
| A-17754-BS | 1930-31, stock style, plain | 65.00 | pr |
| A-17754-SS | 1930-31, stock style, stainless | 225.00 | pr |
| A-17754-SS32 | 1928-31, uses 1932 bumper, stainless | 225.00 | ea |

1928-29 Bumper Brackets to Frame Bolts

| | | | |
|--------------|-----------|-------|-----|
| A-17754-SKSS | Stainless | 15.00 | set |
|--------------|-----------|-------|-----|

1926-31 Bumpers, cont

1930-31 Front Bumper Bracket & Splash Apron Studs

Set of 4 special studs that mount the front bumper brackets and space the front splash apron from the frame.

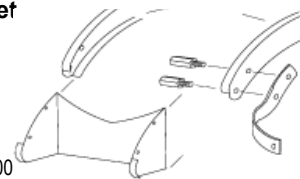

| | | | |
|------------|-------|-------|--|
| A-16527-AS | studs | 25.00 | |
|------------|-------|-------|--|

Rear I Brack

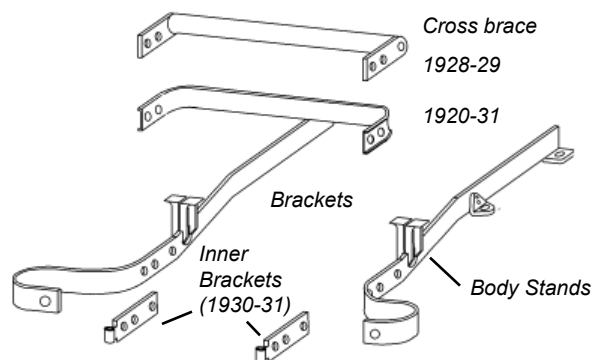

Rear Bumper Brackets: (with body stands)

| | | | |
|------------|--|--------|----|
| A-17777-CR | 1928-31 Coupe & Roadster | 190.00 | pr |
| A-17777-AS | 1928-29 Sedans, 1928-31 4-Door Phaeton | 190.00 | pr |
| A-17777-BS | 1930-31 Tudor sedan | 190.00 | pr |

Rear Inner Brackets: (used on 1930-31 only)

| | | | |
|-----------|---|-------|----|
| A-17777-I | 1930-31 Coupe, Roadster, Sedan, Phaeton | 17.50 | ea |
|-----------|---|-------|----|

Bumper Cross Tubes:

| | | | |
|------------|------------------------------------|--------|----|
| A-17783-A | 1928-30 Rear cross tube, plain | 80.00 | ea |
| A-17783-AS | 1928-31 Rear cross tube, stainless | 155.00 | ea |
| A-17783-B | 1930-31 Rear cross 1/2 round bar | 40.00 | ea |

Rear Bumper Bracket to Body Stands only

| | | | |
|------------|-----------------------------------|-------|----|
| A-17778-B5 | 1928-31 Coupe & Roadster, 5" tall | 17.50 | ea |
| A-17778-B4 | 1930-31 Sedan, 4.5" tall | 17.50 | ea |
| A-17778-B3 | 1928-29 Sedan, 3" tall | 17.50 | ea |

Model A Luggage Rack

Stamped steel, chrome plated with wood trim and mounting brackets.

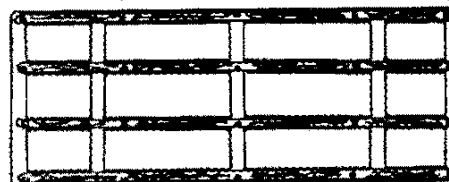

| | | | |
|---------|--|--------|----|
| A-18575 | | 130.00 | ea |
|---------|--|--------|----|

1932 Bumpers

1932 Bumper and Bolts

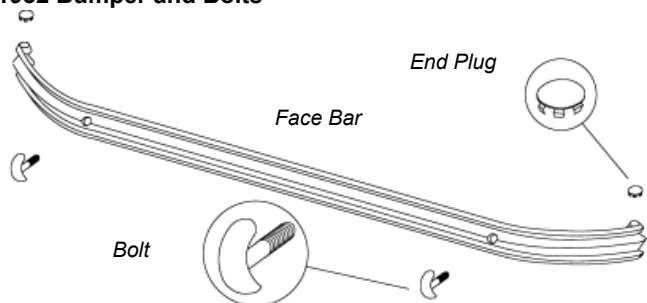

| | | | |
|------------|----------------------------------|--------|----|
| B-17757 | 1932 Bumper face bars, chrome | 350.00 | ea |
| B-17758 | 1932 Bumper bolt, stainless clad | 12.50 | ea |
| B-17760-SS | 1932 Bumper end plugs, stainless | 5.00 | ea |

1932 Bumper Brackets

Fit All body style



| | Plain | Stainless | | |
|---------|------------|-----------|-------------|-----------|
| Stock | B-17754-S | 65.00 pr | B-17754-SS | 225.00 pr |
| Shortie | B-17754-SH | 115.00 pr | B-17754-SSH | 225.00 pr |

Front Bumper Bracket Mount Kit

Includes special studs to offset splash apron from frame. Bolts and studs mount bumper brackets and front spreader bar to frame

| | | |
|-----------|-------|-----|
| B-16525-S | 15.00 | set |
|-----------|-------|-----|

1932 Rear Bumper Brackets

Fit passenger models only



| | Plain | Stainless | | |
|---------|-------------|-----------|-------------|-----------|
| Stock | B-17314-AS | 65.00 pr | B-17314-SS | 225.00 pr |
| Shortie | B-17314-ASH | 115.00 pr | B-17314-SSH | 225.00 pr |

Front License Plate Bracket

Black

| | | | |
|----------|-------|-------|----|
| B-5034-B | black | 30.00 | ea |
|----------|-------|-------|----|

Stainless

| | | | |
|----------|-----------|-------|----|
| B-5034-C | stainless | 30.00 | ea |
|----------|-----------|-------|----|

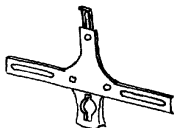

Luggage Racks

Stamped steel; includes stainless trim, mounting brackets, and fasteners. Finest quality USA manufacture.

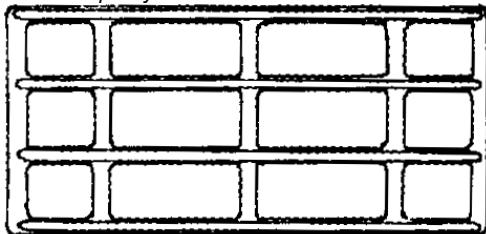

| | | | |
|---------|------------------------------------|--------|----|
| B-18575 | Includes special rear spreader bar | 625.00 | ea |
|---------|------------------------------------|--------|----|

1933-36 Bumpers

1933-36 Bumper Face Bars

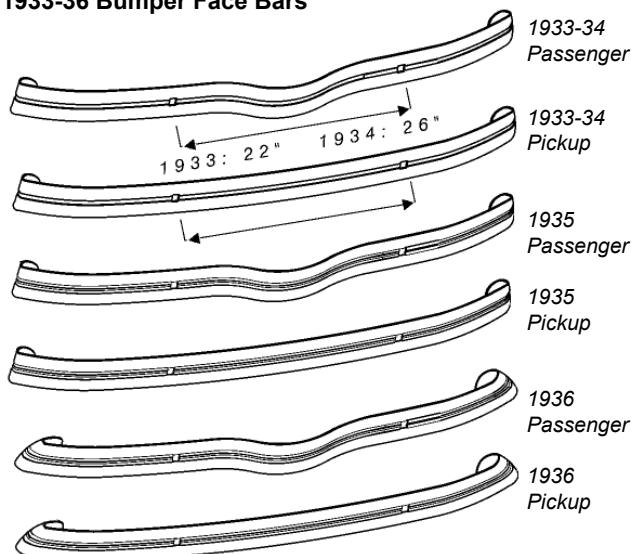

Note: Passenger and Pickup bumpers of the same year are interchangeable

| | Chrome | | Stainless | |
|--------------------|------------|-----------|-------------|-----------|
| 1933 Passenger | 40-17757-A | 350.00 ea | 40-17757-AS | 450.00 ea |
| 1933 Pickup | 46-17757-A | 350.00 ea | 46-17757-AS | 450.00 ea |
| 1934 Passenger | 40-17757-B | 350.00 ea | 40-17757-BS | 450.00 ea |
| 1934 Victoria Rear | 40-17757-V | 400.00 ea | | |
| 1934 Pickup | 46-17757-B | 350.00 ea | 46-17757-BS | 450.00 ea |
| 1935 Passenger | 48-17757 | 350.00 ea | 48-17757-S | 450.00 ea |
| 1935 Pickup | 50-17757 | 350.00 ea | 50-17757-S | 450.00 ea |
| 1936 Passenger | 68-17757 | 350.00 ea | 68-17757-S | 450.00 ea |
| 1936 Pickup | 67-17757 | 350.00 ea | 67-17757-S | 450.00 ea |

Bumper Guards

1933-34 All models:
40-17996 25.00 ea

1933-34 bumper guard bolts
40-17758-R 7.50 ea

1935 All models:
48-17996 60.00 ea

1936 All models:
68-17996 60.00 ea

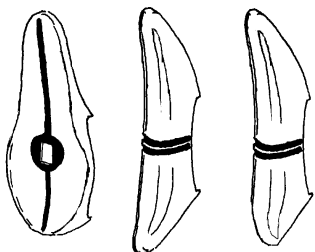

Bumper Bolts

Oval Head (Bumper Face)
40-17758 stainless 7.50 ea

Round Head (Bumper End)
B-42034-P plain 0.50 ea
B-42034-S stainless clad 1.00 ea

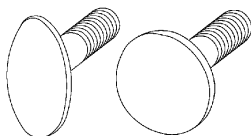

Accessory Grille Guard

1933-36 All models, chrome plated.

40-17799-GG 155.00 ea

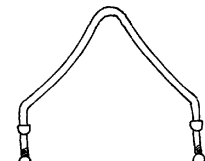

Front License Plate Brackets

Black:
40-5034-B 22.50 ea

Stainless:
40-5034-C 27.50 ea

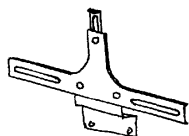

1933-36 Bumpers

1933-36 Front Bumper Bracket Sets

Fit Passenger or Pickup, set of 4 pieces

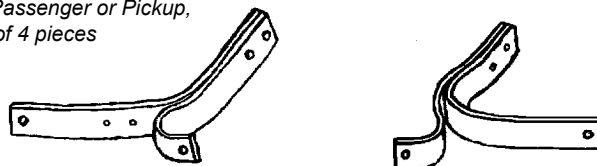

| | Mild Steel | | Stainless | |
|------|-------------|-----------|--------------|------------|
| 1933 | 40-17754-AS | 125.00set | 40-17754-ASS | 375.00 set |
| 1934 | 40-17754-BS | 125.00set | 40-17754-BSS | 375.00 ea |
| 1935 | 48-17754-S | 125.00set | 48-17754-SS | 375.00 set |
| 1936 | 68-17754-S | 125.00set | 68-17754-SS | 375.00 set |

1935-36 Front Bumper Arm Grommets

1935 Passenger & Commercial:

(hole in fender for bumper arm)
48-17772-S 22.50 pr

1936-37 Commercial:

(notch in fender for bumper arm)
50-17772/3 22.50 pr

1936-37 Passenger:

68-17772/3 22.50 pr



1933-36 Rear Bumper Bracket Sets



| | Mild Steel | | Stainless | |
|---------------------|-------------|-----------|--------------|-----------|
| 1933 Pass, Stock | 40-17314-AS | 65.00 pr | | |
| 1933 Pass, Shorty | 40-17314-AH | 115.00 pr | 40-17314-AHS | 225.00 pr |
| 1934 Pass, Stock | 40-17314-BS | 65.00 pr | | |
| 1934 Pass, Shorty | 40-17314-BH | 115.00 pr | 40-17314-BHS | 225.00 pr |
| 1934 Victoria | 40-17314-VS | 125.00 pr | | |
| 1935 Pass Stock | 48-17314-S | 65.00 pr | | |
| 1936 Pass Stock | 68-17314-S | 65.00 pr | | |
| 1935-36 Pass Shorty | 48-17314-H | 115.00 pr | 48-17314-HS | 225.00 pr |
| 1935-36 Pickup | 67-17314-S | 125.00set | | |

1934 Victoria Rear Bumper Arm Grommets

40-17792-V 1934 Victoria, rubber 35.00 pr

Luggage Racks

Stamped steel; includes stainless trim, mounting brackets, and fasteners. 1934-36 include emblems. Finest quality USA manufacture.

1933 Passenger
40-18575-A 625.00 ea

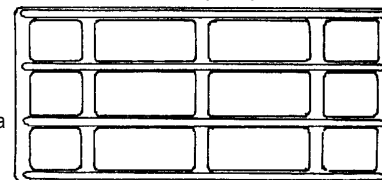

1934 Passenger
40-18575-B 625.00 ea

1935-36 Passenger
48-18575 625.00 ea

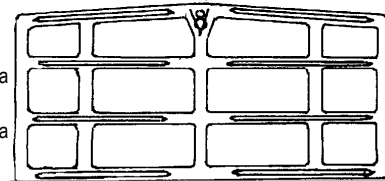

Ribbed Style Bumpers

Classic 5 Rib Style Bumpers

Extruded aluminum and highly polished.
Mounting holes are not drilled, allowing these to fit most years.

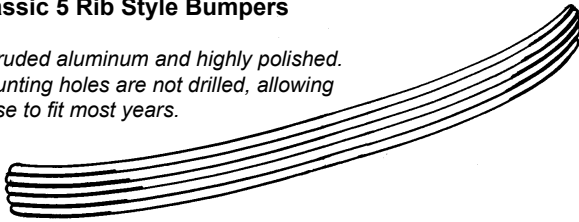

| | | | |
|---------------|----------------------------------|--------|----|
| HR-17757-D64F | Flat arc w/curved ends, 64" wide | 250.00 | ea |
| HR-17757-D64A | 1940 Ford arc, 64" wide | 250.00 | ea |
| HR-17757-D66F | Flat arc w/curved ends, 66" wide | 250.00 | ea |
| HR-17757-D66A | 1940 Ford arc, 66" wide | 250.00 | ea |
| HR-17757-D68F | Flat arc w/curved ends, 68" wide | 250.00 | ea |

1949 Chev Style License Plate Guard

For "DeSoto" 5 rib bumpers, aluminum

| | | |
|--------------|--------|----|
| HR-17757-CLG | 165.00 | ea |
|--------------|--------|----|

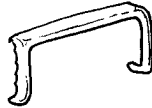

The Custom 3-Rib Style Bumpers

Three-rib style similar to DeSoto style.
Extruded aluminum and highly polished.
These look best on earlier cars such as 1928-34 Fords.

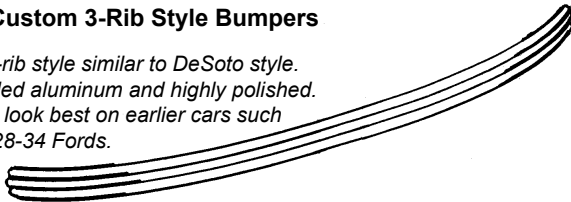

| | | | |
|---------------|----------------------------------|--------|----|
| HR-17757-R64F | Flat arc w/curved ends, 64" wide | 250.00 | ea |
| HR-17757-R64A | 1940 Ford arc, 64" wide | 250.00 | ea |
| HR-17757-R66F | Flat arc w/curved ends, 66" wide | 250.00 | ea |
| HR-17757-R66A | 1940 Ford arc, 66" wide | 250.00 | ea |
| HR-17757-R68F | Flat arc w/curved ends, 68" wide | 250.00 | ea |

Bumper Face Bolt for DeSoto or 3-Rib Bumper

| | | | |
|-------------|-----------------|-------|----|
| HR-17758-DS | stainless steel | 10.00 | ea |
|-------------|-----------------|-------|----|

1937-40 Pass, 1937-41 Pickup Bumper

Bumper Face Bars

1937-38 & 1939 Std & Pickup

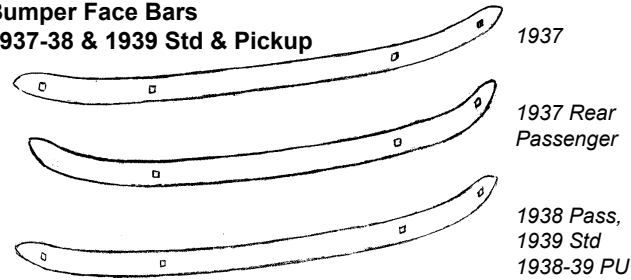

| | Chrome | | Stainless | |
|------------------------|------------|-----------|-------------|-----------|
| 1937 Front (& PU rear) | 78-17757-A | 350.00 ea | 78-17757-AS | 450.00 ea |
| 1937 Pass Rear | 78-17757-B | 350.00 ea | 78-17757-BS | 450.00 ea |
| 1938 Pass, 1939 Std | 81A-17757 | 350.00 ea | 81A-17757-S | 450.00 ea |
| 1938-39 Pickup | | | | |

Bumper Face Bars

1939 Deluxe, 1940 Passenger, 1940-41 Pickup

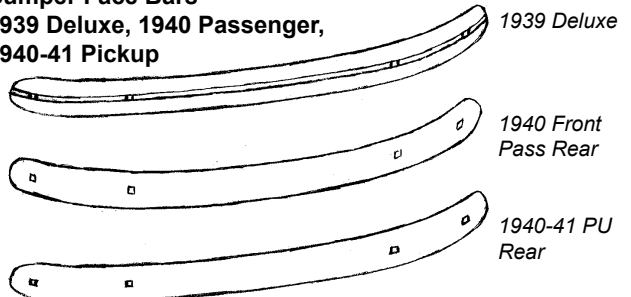

Chrome bumper face bars have stock mounting holes. Smooth stainless face bars have studs welded and do not have exposed bolt heads.

| | Chrome | | Smooth Stainless | |
|----------------------|-------------|-----------|------------------|-----------|
| 1939 Deluxe | 91A-17757 | 350.00 ea | 91A-17757-HR | 475.00 ea |
| 1940 Passenger | 01A-17757 | 350.00 ea | 01A-17757-HR | 475.00 ea |
| 1940-41 Pickup Front | | | | |
| 1940 Ford Script | 01A-17757-F | 400.00 ea | | |
| 1940-41 PU Rear | 01C-17757 | 350.00 ea | 01C-17757-HR | 475.00 ea |

Bumper Guards, Chrome Plated

| | | |
|------------------------------|-----------|----------|
| 1937 All models | 78-17996 | 60.00 ea |
| 1939 Deluxe passenger | 91A-17996 | 60.00 ea |
| 1940 All models | 01A-17996 | 50.00 ea |

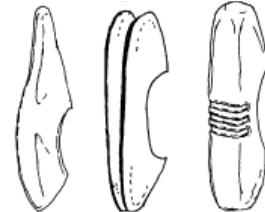

1940 Grille Guard

Ford script, steel, chrome plated

| | |
|-----------|-----------|
| 01A-17799 | 300.00 ea |
|-----------|-----------|

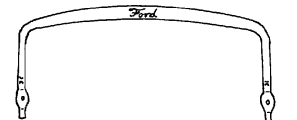

Bumper Face Bolts

Oval Head
Stainless, fine thread
1933-40 Oval Head

| | | | |
|----------|-------------|------|----|
| 40-17758 | 1 1/4" long | 7.50 | ea |
|----------|-------------|------|----|

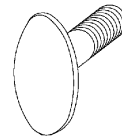

Front License Plate Brackets

1937-38 Pass & 1939 Std, 1937-39 Pickup:

| | | | |
|-----------|-----------|-------|----|
| 78-5034-B | Black | 32.50 | ea |
| 78-5034-C | Stainless | 40.00 | ea |

1939 Deluxe, All 1940, 1940-41 Pickup:

| | | | |
|------------|-----------|-------|----|
| 91A-5034-B | Black | 22.50 | ea |
| 91A-5034-C | Stainless | 27.50 | ea |

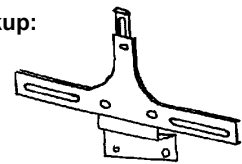

1937-40 Pass, 1937-41 Pickup Bumper

Front Bumper Brackets (Set of 4)

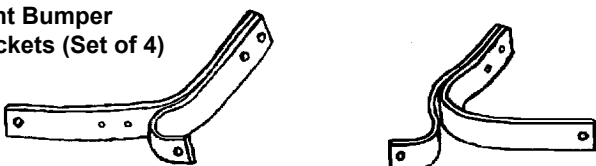

| | Plain | | Stainless | |
|---------------------|-------------|-----------|--------------|------------|
| 1937 | 78-17754-S | 125.00set | 78-17754-SS | 375.00 set |
| 1938 Pass, 1939 Std | 81A-17754-S | 125.00set | 81A-17754-SS | n.a |
| 1938-39 Pickup | | | | |
| 1939 Deluxe | 91A-17754-S | 125.00set | | |
| 1940 Pass, 40-41 PU | 01A-17754-S | 125.00set | 01A-17754-SS | 375.00 ea |

Front Bumper Arm Grommets, rubber

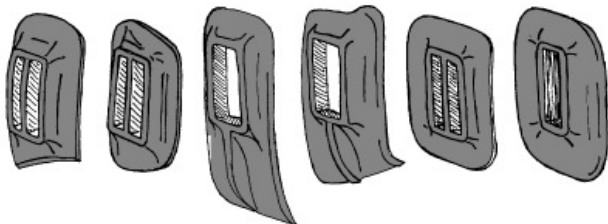

| | | | |
|-------------|---|-------|----|
| 48-17772-S | 1935 Passenger & Commercial | 22.50 | pr |
| 50-17772/3 | 1936-37 Commercial | 22.50 | pr |
| 68-17772/3 | 1936-37 Passenger, 1938 Standard | 22.50 | pr |
| 81A-17772/3 | 1938 Deluxe, 1939 Standard | 22.50 | pr |
| 81C-17772/3 | 1938-39 Commercial | 22.50 | pr |
| 99A-17772-S | 1939-40 Mercury | 42.50 | pr |
| 01A-17772/3 | 1939-40 Deluxe, 1940 Std, 1940-41 1/2 Ton | 22.50 | pr |

Rear Bumper Brackets (set of 4)



| | Plain | | Stainless | |
|---------------------|-------------|-----------|--------------|------------|
| 1937 Passenger | 78-17314-S | 125.00set | 78-17314-SS | 375.00 set |
| 1937 Pickup | 77-17314-S | 125.00set | | |
| 1938 Pass, 1939 Std | 81A-17314-S | 125.00set | 81A-17314-SS | n.a |
| 1938-41 Pickup | 81C-17314-S | 125.00set | | |
| 1939 Delxue | 91A-17314-S | 125.00set | | |
| 1940 Passenger | 01A-17314-S | 125.00set | 01A-17314-SS | 375.00 ea |

Rear Bumper Arm Grommets, rubber

| | | | |
|-----------------------------------|-------|----|--|
| 1937-40 Coupe Convertible, | | | |
| 1937 Sedans and Phaeton, | | | |
| 1938 Standard Sedans: | | | |
| 78-17792/3 | 22.50 | pr | |
| 1938 Deluxe Sedan | | | |
| 1939-40 Sedan: | | | |
| 81A-17792/3 | 22.50 | pr | |
| 1940-41 Sedan Delivery: | | | |
| 01A-17792 | 30.00 | pr | |

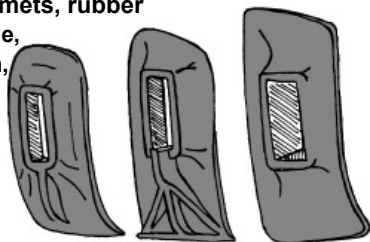

Rear Bumper Splash & Rock Guards

Mounts to bumper bracket and helps deflect rocks and splash from coming up onto rear deck.



| | | | |
|--------|----------------------------|--------|----|
| BSA40P | 1940 Passenger: fiberglass | 155.00 | ea |
|--------|----------------------------|--------|----|

1941-48 Bumpers

1941 Passenger Bumper Arm Grommets

| | | | |
|-------------|-------|-------|----|
| 11A-17772/3 | Front | 22.50 | pr |
| 11A-17792/3 | Rear | 22.50 | pr |

1942-48 Front Bumper Bracket to Bumper

| | | | |
|-------------|----------|-------|-----|
| 21A-17749-B | Set of 4 | 20.00 | set |
|-------------|----------|-------|-----|

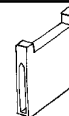

1946-48 Rear Bumper Splash Guards

Mounts to bumper bracket and helps deflect rocks and splash from coming up onto rear deck.

| | | | |
|----------|----------------------------------|--------|----|
| 6A-17808 | Splash guard, Stamped Steel | 275.00 | ea |
| 6A-17832 | Splash guard to body rubber seal | 20.00 | ea |

Bumper Face Bolts

Stainless clad, fine thread

1941-48 Square Head

| | | | |
|-----------|-------------|-------|----|
| 11A-17758 | 1 1/4" long | 10.00 | ea |
| 11A-17908 | 2 1/2" long | 17.50 | ea |
| 21A-17908 | angled | 17.50 | ea |

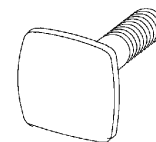

1942-47 Pickup Bumpers

1942-47 Pickup Bumper Face Bar

| | | | |
|--------------|---------------------------------------|--------|----|
| 21C-17757-S | Stainless: w/holes for bolts | 475.00 | ea |
| 21C-17757-HR | Stainless, smoothie, with mount studs | 475.00 | ea |

1948-56 Pickup Bumpers

Front Bumpers

with brackets riveted on

| | | | |
|-------------------|--------|----|--|
| 1948-52 Plain: | | | |
| 7C-17750-A | 175.00 | ea | |
| 1948-52 Stainless | | | |
| 7C-17750-SS | 375.00 | ea | |

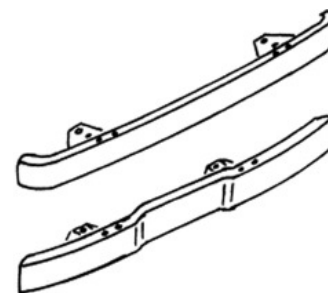

| | | | |
|--------------------|--------|----|--|
| 1953-56 Plain | | | |
| BAAA-17750-B | 175.00 | ea | |
| 1953-56 Stainless: | | | |
| BAAA-17750-SS | 375.00 | ea | |

Rear Bumpers, 1948-56

| | | | |
|---------------------|--------|----|--|
| Face Bar, Plain | | | |
| BAAA-17906-A | 150.00 | ea | |
| Face Bar, Stainless | | | |
| BAAA-17906-SS | 375.00 | ea | |

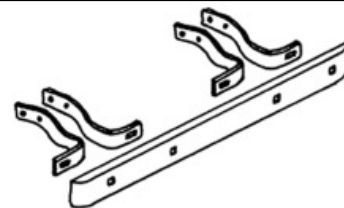

Rear Bumper Brackets

2 left and 2 right brackets are needed for rear bumper.

| | | | |
|-------------|----------------------------------|--------|-----|
| B5C-17787-S | Rear bumper bkts, 4pc set, 48-56 | 150.00 | set |
|-------------|----------------------------------|--------|-----|

Bumper Face Bolts

Round Head, coarse thread

| | | | |
|-----------|----------------|------|----|
| B-42034-P | Plain | 0.50 | ea |
| B-42034-S | Stainless clad | 1.00 | ea |

