

## Outside Door and Deck Lid Handles

### Door Handles:

#### 1926-27 Coupe and Sedan 1928-29 Closed Pickup

Handles, Die Cast, Chromed  
Non Locking, Fit RH or LH

A-702350-P	27.50 ea
Rubber Pads B-35630	5.00 pr
Mount screws, stainless 3/4" set of 4 B-46212-MS	1.00 set
Lock Cylinder (originally 26-27 only) B-41650	12.50 ea

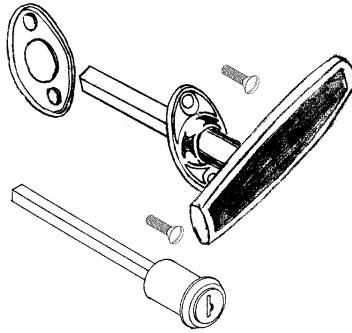

### Door Handles: 1928-29 Coupe & Tudor Door

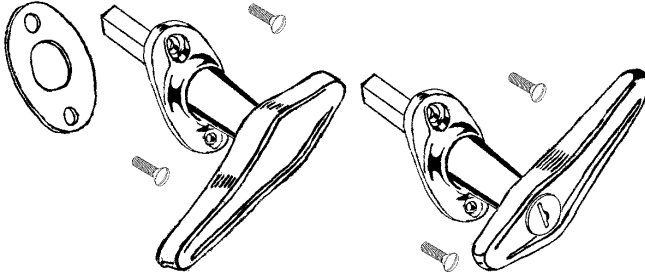

A-702350-AL	RH Handle, locking, diecast, chrome	45.00 ea
A-702351-A	LH Handle, non-locking, diecast, chrome	32.50 ea
A-702350/1-AL	Locking handles w/matching keys note: requires modification to LH door	90.00 ea
A-702356-B	Rubber pads (no bead)	1.50 pr
B-46212-MS	Mounting screws, stainless 3/4" set of 4	1.00 set

### Deck Lid Handle: 1928-31 Coupe & Roadster

Locking, w/keys,  
mount outside lid.  
Die Cast, chrome  
plated. Will fit all 1928-37.

Handle: A-702352-A	40.00 ea
Rubber pad (w/bead) B-41648	5.00 ea
Acorn nut w/special lockwasher A-41606-S	2.50 ea

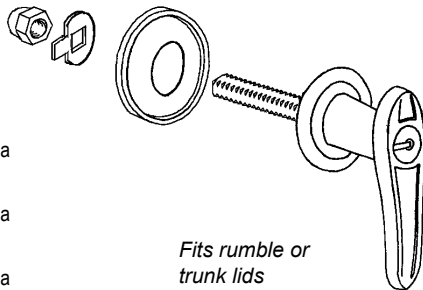

*Fits rumble or  
trunk lids*

### Door Handles:

#### 1928-30 (Straight Windshield) Fordor & Cabriolet

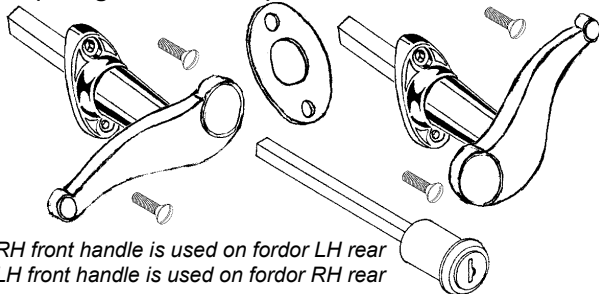

*RH front handle is used on fordor LH rear  
LH front handle is used on fordor RH rear*

A-702350-C	RH Front Handle, non-locking, diecast chrome	32.50 ea
A-702351-C	LH Front Handle, non-locking, diecast chrome	32.50 ea
A-702356-C	Rubber pads (no bead)	1.00 pr
B-46212-WS	Mount screws, Chrome for wood, set of 4	1.00 set
B-41650	Key Cylinder (Briggs & Stratton replacement)	12.50 ea

### Door Handles: 1930-31 Coupe, Tudor & Closed Pickup

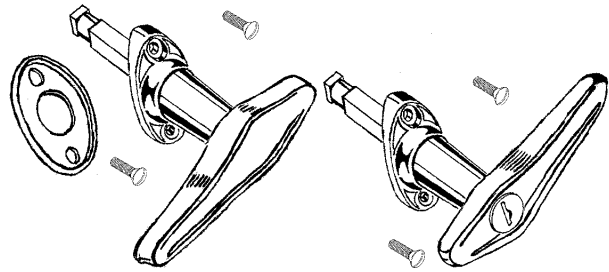

A-702350-BL	RH Handle, locking, diecast, chrome	45.00 ea
A-702351-B	LH Handle, non-locking, diecast, chrome	32.50 ea
A-702350/1-BL	Locking handles with matching keys note: requires modifications to LH door	90.00 ea
B-46212	Rubber pads (with bead)	5.00 pr
A-702356-D	Rubber pads (no bead)	1.50 pr
B-46212-MS	Mounting screws, stainless 3/4" set of 4	1.00 set

### Door Handles:

#### 1930-31 (Slant Windshield) Fordor Cabriolet Victoria

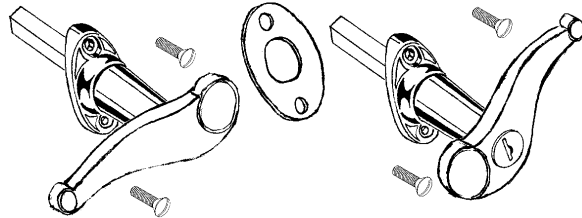

A-702350-DL	RH Front Handle, locking, diecast, chrome	45.00 ea
A-702350-D	Fordor LH rear Handle, non-locking, chrome	32.50 ea
A-702351-D	LH Front Handle, non-locking, diecast chrome	32.50 ea
	RH Rear Handle	
B-46212	Rubber pads (with bead)	5.00 pr
A-702356-D	Rubber pads (no bead)	1.50 pr
B-46212-MS	Mounting screws, stainless 3/4" set of 4	1.00 set

### Deck Lid Handle: Cabriolet

Locking, w/keys,  
mount outside lid.  
Die Cast, chrome  
plated.  
Will fit 1928-37.

A-702352-B	Handle	40.00 ea
B-41648	Handle Pad, rubber	5.00 ea
A-41606-S	Acorn nut w/special lockwasher	2.50 ea

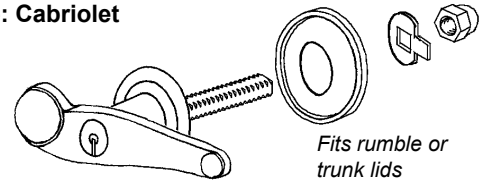

*Fits rumble or  
trunk lids*

### Door Handle: 1928-33 Roadster & Phaeton

Handles, Die Cast, Chromed A-702350-O	27.50 ea
Rubber Pads B-35630	5.00 pr
Mount screws, stainless 3/4" set of 4 B-46212-MS	1.00 set

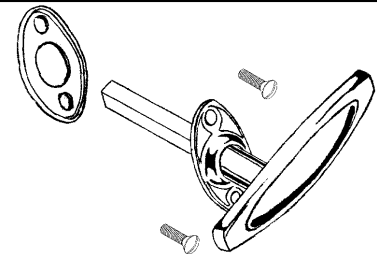

\* Parts with price listed as "not.avbl" are not known to be available at this time, but are listed for reference.

## Outside Door and Deck Lid Handles, cont

### Door Handle: 1932 Sedan, 5 Window Coupe, & Cabriolet

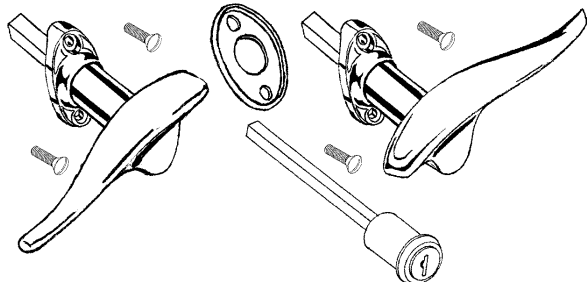

B-702350	RH Front (LR) Handle, Diecast, chrome	25.00 ea
B-702351	LH Front (RR) Handle, Diecast, chrome	27.50 ea
B-702350/1	RH & LH Handles, stainless clad as original	115.00 pr
B-46212	Rubber pads (with bead)	5.00 pr
B-46212-MS	Mounting screws, stainless 3/4" set of 4	1.00 set
B-41650	Key Cylinder (Briggs & Stratton replacement)	12.50 ea

### Door Handle: 1932 3 Window, 1933-34 Coupes, Sedans, & Cabriolet

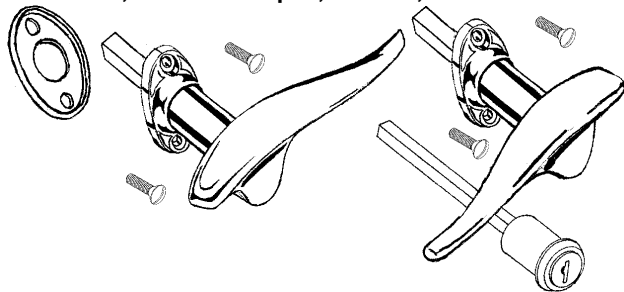

40-702350	RH Front (LR) Handle, nonlock, chrome	27.50 ea
40-702351	LH Front (RR) Handle, nonlock, chrome	27.50 ea
40-702350/1-L	RH & LH Handles, locking, diecast chrome	70.00 pr
40-702350/1	RH & LH Handles, nonlock, stainless clad	115.00 pr
B-46212	Rubber pads (with bead)	5.00 pr
B-46212-MS	Mounting screws, stainless 3/4" set of 4	1.00 set
B-41650	Key Cylinder (Briggs & Stratton replacement)	12.50 ea

### Deck Lid Handle: 1932-34 Rumble or Trunk Lid Handle

*Locking, w/keys, mount outside lid. Die Cast, chrome plated. Will fit 1928-37.*

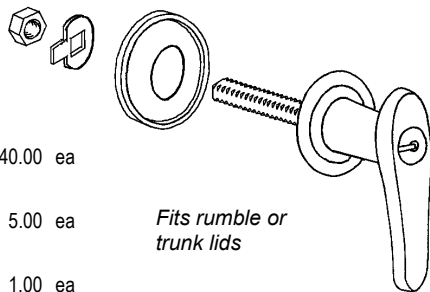

Handle:		
40-702352		40.00 ea
Handle pad, rubber		
B-41648		5.00 ea
Hex nut w/special lockwasher		
B-41606-S		1.00 ea

*Fits rumble or trunk lids*

### Door Handle: 1932-34 Pickup & Panel

Handles, Die cast, Chrome Plated		
46-702350		32.50 ea
Rubber Pads		
B-46212		5.00 pr
Mount screws, stainless 3/4" set of 4		
B-46212-MS		1.00 set
Lock Cylinder (originally 26-27 only)		
B-41650		12.50 ea

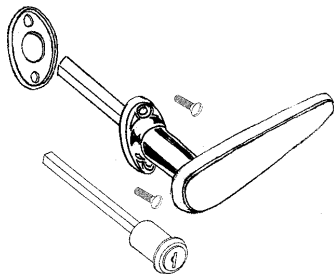

### Door Handle:

#### 1935 Passenger

Handles, Die cast, Chrome Plated		
48-702350		32.50 ea
Rubber Pads		
48-702356		5.00 pr
Mount screws, stainless 3/4" set of 4		
B-46212-MS		1.00 set
Lock Cylinder, w/flipper over keyhole		
48-702302		45.00 ea

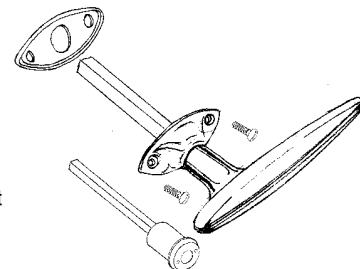

### Door Handle:

#### 1935-36 Pickup & Panel

Handles, Die cast, Chrome Plated		
50-702350		27.50 ea
Rubber Pads		
B-46212		5.00 pr
Mount screws, stainless 3/4" set of 4		
B-46212-MS		1.00 set
Lock Cylinder, w/flipper over keyhole		
48-702302		45.00 ea

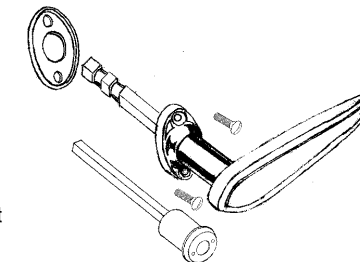

### Door Handle: 1936 Standard

Handles, Die cast, Chrome Plated		
68-702350-A		32.50 ea
Rubber Pads		
48-702356		5.00 pr
Mount screws, stainless 3/4" set of 4		
B-46212-MS		1.00 set
Lock Cylinder, w/flipper over keyhole		
48-702302		45.00 ea

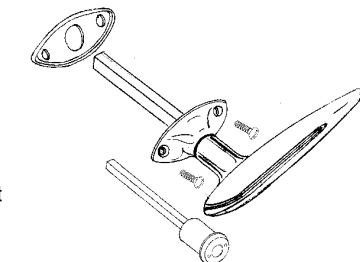

### Door Handle:

#### 1936 Deluxe, 1937 Pickup & Panel

Handles, Die cast, Chrome Plated		
68-702350-B		32.50 ea
Rubber Pads		
48-702356		5.00 pr
Mount screws, stainless 3/4" set of 4		
B-46212-MS		1.00 set
Lock Cylinder, w/flipper over keyhole		
48-702302		45.00 ea

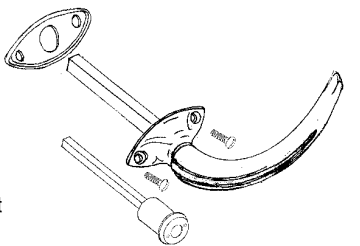

### Deck Lid Handle 1935-36

*Locking, w/keys, mount outside lid. Die Cast, chrome plated. Will fit 1928-37.*

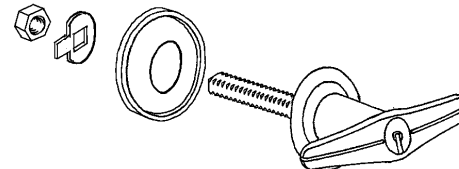

48-702352	Handle	35.00 ea
B-41648	Handle Pad, rubber	5.00 ea
B-41606-S	Hex nut w/special lockwasher	1.00 ea

\* Parts with price listed as "not.avbl" are not known to be available at this time, but are listed for reference.

## Outside Door and Deck Lid Handles, cont

### Door Handle: 1937 Passenger 1937-40 Station Wagon

Handles, Die cast, Chrome Plated

78-702350 32.50 ea

Rubber Pads

48-702356 5.00 pr

Lock Cylinder, w/flipper over keyhole

48-702302 45.00 ea

Screws, stainless, set of 4

B-46212-MS Pass 1.00 set

B-46212-WS Stn Wgn 1.00 set

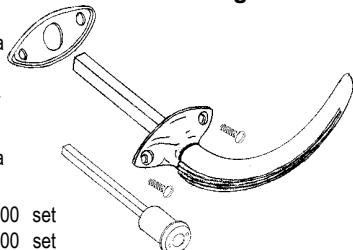

### Deck Lid Handle 1937 Passenger

Locking, w/keys,  
mount outside lid.  
Die Cast, chrome  
plated. Will fit 1928-37.

Handle:

78-702352 45.00 ea

Handle pad, rubber

B-41648 5.00 ea

Hex nut w/special lockwasher

B-41606-S 1.00 ea

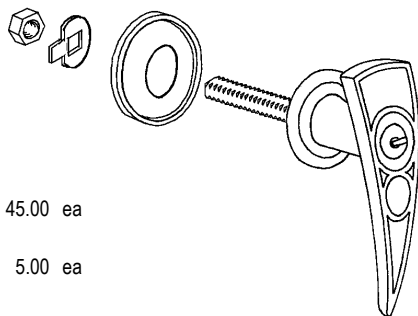

### Door Handle: 1938 Standard 1938-47 Pickup

Handles, Die cast, Chrome Plated

81A-702350-A 32.50 ea

Rubber Pads

48-702356 5.00 pr

Mount screws, stainless 3/4" set of 4

B-46212-MS 1.00 set

Lock Cylinder, w/flipper over keyhole

48-702302 45.00 ea

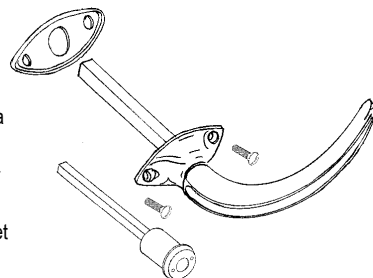

### Door Handle: 1938 Deluxe

Handles, Die cast, Chrome Plated

81A-702350-B 32.50 ea

Rubber Pads

91A-702356 5.00 pr

Lock Cylinder, w/flipper over keyhole

48-702302 45.00 ea

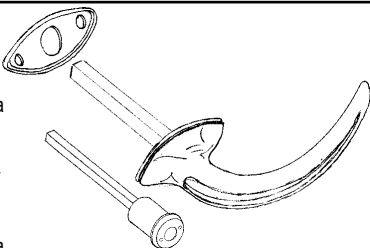

### Door Handle: 1939 Passenger

91A-702350 Handles, die cast, chrome 32.50 ea

91A-702356 Rubber pads 5.00 pr

48-702302 Lock cylinder, flipper style 45.00 ea

### Deck Handle Parts: 1938-39

81A-13573 1938-39 Deck handle to base seal 2.00 ea

81A-13568 1938-39 License lens gasket 1.50 ea

81A-13567 Deck handle base extension nuts 7.50 ea

81A-13572 1938-39 Ford Deck Handle Pad, rubber 15.00 ea

### Door Handle: 1940 Passenger

01A-702350 Handles, die cast, chrome, Coupe & Sedan 32.50 ea

01A-702350-A Handles, die cast, chrome, Convertible not.avbl

01A-702356-A Rubber pads, Coupe & Sedan 5.00 pr

01A-702356-B Rubber pads, Convertible 5.00 pr

48-702302 Lock cylinder, flipper style 45.00 ea

### Deck Lid Handle:

1939 Mercury

1940 Ford

*Note: Part numbers with 99A- prefix fit both 1939 Mercury and 1940 Ford. Part numbers with 01A- prefix only fit 1940 Ford.*

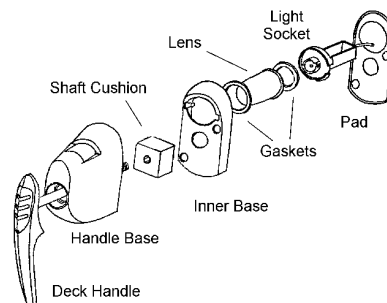

01A-7043500	Deck handle only	55.00 ea
99A-13553	Deck handle outer base only	27.50 ea
99A-13556-S	Deck handle inner base only	15.00 set
99A-13556-SK	License light socket/lens/gasket ki	22.50 ea
01A-13557	Handle shaft to inner base seal/ cushion	1.00 ea
01A-13567	Handle base mount extension nut	7.50 ea
99A-13553-HK	Handle base stud kit	5.00 ea
99A-13572	Deck Handle Pad, rubber	5.00 ea
B-41606-S	Deck handle nut and lockwasher	1.00 ea
99A-13564	Deck light lens (included in 99A-13556-SK)	7.50 ea
99A-13568/9	Lens gaskets (included in 99A-13556-SK)	2.00 ea
01A-43370	Deck lid "Ford V 8" emblem	17.50 ea
01A-7043370-RP	Deck lid emblem rubber pad	7.50 ea

### Deck Handle Parts: 1940 Mercury

09A-13572 1940 Mercury Deck Handle Pad, rubber 35.00 ea

### Door Handles: 1941 Passenger

11A-702350 Handles, die cast, chrome 32.50 ea

91A-702356 Rubber pads 5.00 pr

48-702302 Lock cylinder, flipper style 45.00 ea

### Door Handles: 1941-48 Station Wagon

11A-7922428-R Handle Pads, rubber, set of 4 not.avbl

### Door Handles: 1942-48 Passenger

51A-702350 1946-47 Passenger 32.50 ea

6A-702350 1947-48 Passenger 32.50 ea

21A-702302 Lock cylinder, teardrop flipper style 45.00 ea

### Deck Handle: 1941-48 Ford

11A-7043511 Deck handle only, chrome 70.00 ea

11A-7043512 Deck handle base, chrome 27.50 ea

99A-13556-SK License light socket/lens/gasket kit 22.50 ea

11A-13572 Deck Handle Pad, Passenger 5.00 ea

21A-13572 Deck Handle Pad, 1942 Super Deluxe 25.00 ea

99A-13564 Deck light lens (included in 99A-13556-SK) 7.50 ea

11A-13568 Lens gaskets (included in 99A-13556-SK) 5.00 set

### Deck Handle Parts: 1941-48 Mercury

09A-13572 1940 Mercury Deck Handle Pad, rubber 35.00 ea

19A-13572 1941 Mercury Deck Handle Pad, rubber 15.00 ea

29A-13572 1942-48 Mercury Deck Handle Pad, rubber 15.00 ea

### Door Handle: 1948-52 Pickup

7C-8122400 Handle, RH, Die Cast, Chrome Plated 40.00 ea

7C-8122401 Handle, LH, Die Cast, Chrome Plated 40.00 ea

7C-8122428 Pads, rubber 5.00 pr

### Door Handle: 1953-56 Pickup

BAAA-8122400-B RH Handle (w/o push button) 40.00 ea

BAAA-8122401-B LH Handle (w/o push button) 40.00 ea

BAAA-8122400-PB Push button kit (button with spring) 12.50 ea

BAAA-8122400-SS Shield under outside handles, stainless 20.00 pr

BAAA-8122428 Rubber pads, 4 pc. set, does both doors 10.00 set

BAAA-8222428-P Rubber pad, Panel Rear Door 5.00 ea

\* Parts with price listed as "not.avbl" are not known to be available at this time, but are listed for reference.